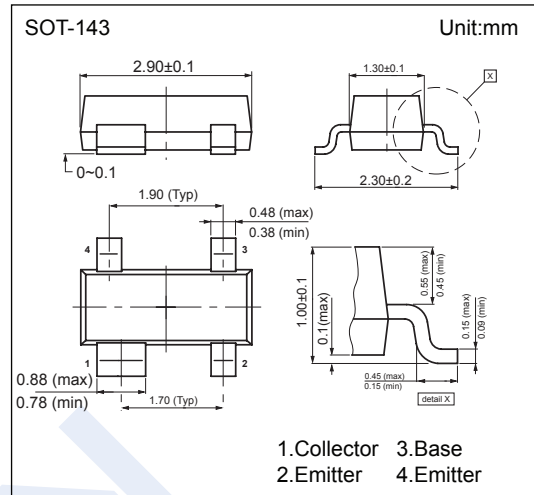

NPN 9GHz Wideband Transistor

BFG540

■ Features

- High power gain
- Low noise figure
- High transition frequency
- Gold metallization ensures excellent reliability.

■ Absolute Maximum Ratings $T_a = 25^\circ\text{C}$

Parameter	Symbol	Rating	Unit
Collector - Base Voltage	V_{CB0}	20	V
Collector - Emitter Voltage shorted base	V_{CES}	15	
Emitter - Base Voltage	V_{EB0}	2.5	
Collector Current - Continuous	I_C	120	mA
Total power dissipation $T_s \leq 60^\circ\text{C}^{*1}$	P_{tot}	400	mW
Thermal resistance from junction to soldering point *1	R_{thJS}	290	$^\circ\text{C}/\text{W}$
Junction Temperature	T_J	150	$^\circ\text{C}$
Storage Temperature Range	T_{stg}	-65 to 150	

*1: T_s is the temperature at the soldering point of the collector pin.

NPN 9GHz Wideband Transistor

BFG540

■ Electrical Characteristics $T_j = 25^\circ\text{C}$, unless otherwise specified.

Parameter	Symbol	Test Conditions	Min	Typ	Max	Unit
Collector- base breakdown voltage	V_{CB0}	$I_C = 100 \mu\text{A}$, $I_E = 0$	20			V
Collector- emitter breakdown voltage	V_{CEO}	$I_C = 1 \text{ mA}$, $I_B = 0$	15			
Emitter - base breakdown voltage	V_{EBO}	$I_E = 100 \mu\text{A}$, $I_C = 0$	2.5			
Collector-base cut-off current	I_{CBO}	$V_{CB} = 8 \text{ V}$, $I_E = 0$			50	nA
DC current gain	h_{FE}	$V_{CE} = 8 \text{ V}$, $I_C = 40 \text{ mA}$	60		250	
Emitter capacitance	C_e	$I_C = I_E = 0$; $V_{EB} = 0.5 \text{ V}$; $f = 1 \text{ MHz}$		2		pF
Collector capacitance	C_c	$I_E = I_C = 0$; $V_{CB} = 8 \text{ V}$; $f = 1 \text{ MHz}$		0.9		
Feedback capacitance	C_{re}	$I_C = 0$; $V_{CB} = 8 \text{ V}$; $f = 1 \text{ MHz}$		0.5		
Noise figure	F	$\Gamma_s = \Gamma_{opt}$; $I_C = 10 \text{ mA}$; $V_{CE} = 8 \text{ V}$; $f = 900 \text{ MHz}$; $T_{amb} = 25^\circ\text{C}$		1.3	1.8	dB
		$\Gamma_s = \Gamma_{opt}$; $I_C = 40 \text{ mA}$; $V_{CE} = 8 \text{ V}$; $f = 900 \text{ MHz}$; $T_{amb} = 25^\circ\text{C}$		1.9	2.4	
		$\Gamma_s = \Gamma_{opt}$; $I_C = 10 \text{ mA}$; $V_{CE} = 8 \text{ V}$; $f = 2 \text{ GHz}$; $T_{amb} = 25^\circ\text{C}$		2.1		
Power gain, maximum available (Note 1)	G_{UM}	$I_C = 40 \text{ mA}$; $V_{CE} = 8 \text{ V}$; $f = 900 \text{ MHz}$; $T_{amb} = 25^\circ\text{C}$		18		
		$I_C = 40 \text{ mA}$; $V_{CE} = 8 \text{ V}$; $f = 2 \text{ GHz}$; $T_{amb} = 25^\circ\text{C}$		11		
Insertion power gain	$ S_{21e} ^2$	$I_C = 40 \text{ mA}$; $V_{CE} = 8 \text{ V}$; $f = 900 \text{ MHz}$; $T_{amb} = 25^\circ\text{C}$	15	16		
Output power at 1dB gain compression	PL_1	$I_C = 40 \text{ mA}$; $V_{CE} = 8 \text{ V}$; $R_L = 50 \Omega$; $f = 900 \text{ MHz}$; $T_{amb} = 25^\circ\text{C}$		21		dBm
Third order intercept point	ITO	Note 2		34		
Output voltage	V_O	Note 3		500		mV
Second order intermodulation distortion	d_2	Note 4		-50		dB
Transition frequency	f_T	$I_C = 40 \text{ mA}$; $V_{CE} = 8 \text{ V}$; $f = 1 \text{ GHz}$; $T_{amb} = 25^\circ\text{C}$		9		GHz

Notes

- G_{UM} is the maximum unilateral power gain, assuming s_{12} is zero and $G_{UM} = 10 \log \frac{|s_{21}|^2}{(1 - |s_{11}|^2)(1 - |s_{22}|^2)}$ dB.
- $V_{CE} = 8 \text{ V}$; $I_C = 40 \text{ mA}$; $R_L = 50 \Omega$; $T_{amb} = 25^\circ\text{C}$;
 $f_p = 900 \text{ MHz}$; $f_q = 902 \text{ MHz}$;
measured at $f_{(2p-q)} = 898 \text{ MHz}$ and $f_{(2q-p)} = 904 \text{ MHz}$.
- $d_{im} = -60 \text{ dB}$ (DIN 45004B); $I_C = 40 \text{ mA}$; $V_{CE} = 8 \text{ V}$; $Z_L = Z_S = 75 \Omega$; $T_{amb} = 25^\circ\text{C}$;
 $V_p = V_O$; $V_q = V_O - 6 \text{ dB}$; $V_r = V_O - 6 \text{ dB}$;
 $f_p = 795.25 \text{ MHz}$; $f_q = 803.25 \text{ MHz}$; $f_r = 805.25 \text{ MHz}$;
measured at $f_{(p+q-r)} = 793.25 \text{ MHz}$.
- $I_C = 40 \text{ mA}$; $V_{CE} = 8 \text{ V}$; $V_O = 275 \text{ mV}$; $T_{amb} = 25^\circ\text{C}$;
 $f_p = 250 \text{ MHz}$; $f_q = 560 \text{ MHz}$; measured at $f_{(p+q)} = 810 \text{ MHz}$.

NPN 9GHz Wideband Transistor BFG540

■ Typical Characteristics

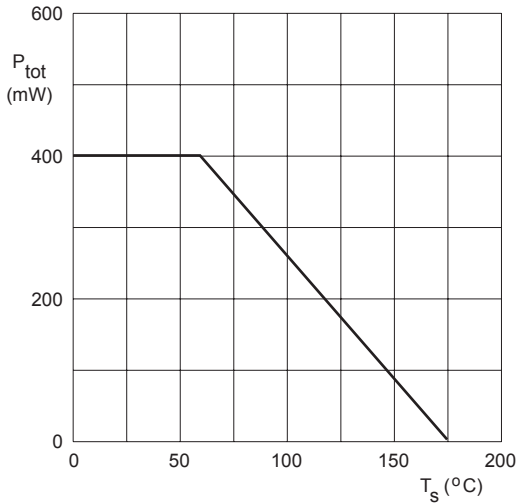

$V_{CE} \leq 10$ V.

Fig.1 Power derating curve.

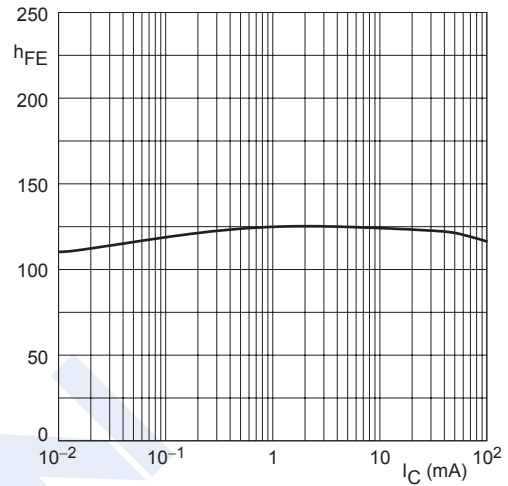

$V_{CE} = 8$ V; $T_j = 25$ °C.

Fig.2 DC current gain as a function of collector current.

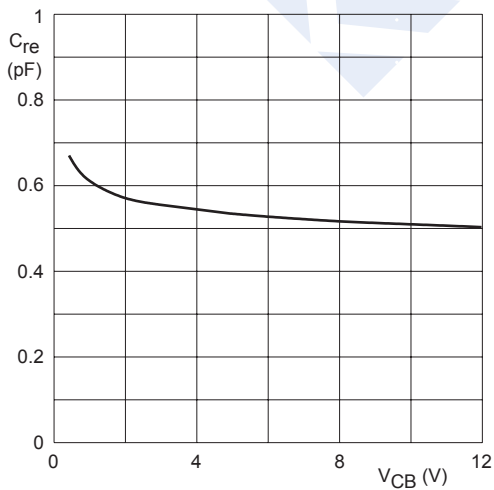

$I_C = 0$; $f = 1$ MHz.

Fig.3 Feedback capacitance as a function of collector-base voltage.

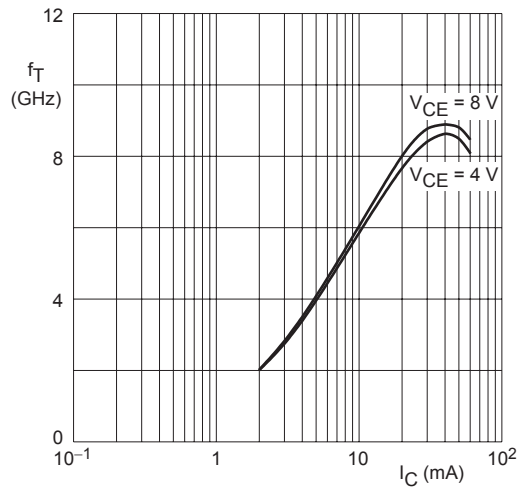

$f = 1$ GHz; $T_{amb} = 25$ °C.

Fig.4 Transition frequency as a function of collector current.

NPN 9GHz Wideband Transistor BFG540

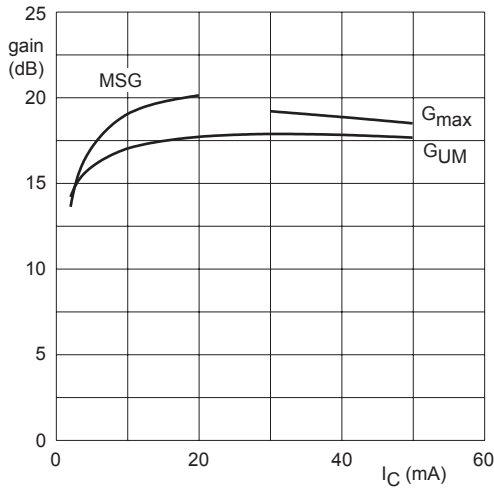

$V_{CE} = 8\text{ V}$; $f = 900\text{ MHz}$.
MSG = maximum stable gain; G_{max} = maximum available gain;
 G_{UM} = maximum unilateral power gain.

Fig.5 Gain as a function of collector current.

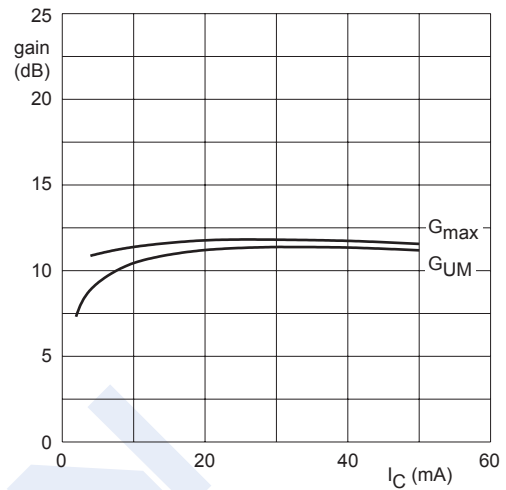

$V_{CE} = 8\text{ V}$; $f = 2\text{ GHz}$.
 G_{max} = maximum available gain;
 G_{UM} = maximum unilateral power gain.

Fig.6 Gain as a function of collector current.

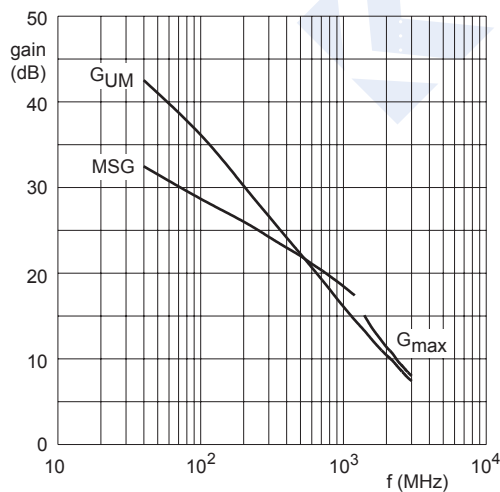

$I_C = 10\text{ mA}$; $V_{CE} = 8\text{ V}$.
 G_{UM} = maximum unilateral power gain;
MSG = maximum stable gain; G_{max} = maximum available gain.

Fig.7 Gain as a function of frequency.

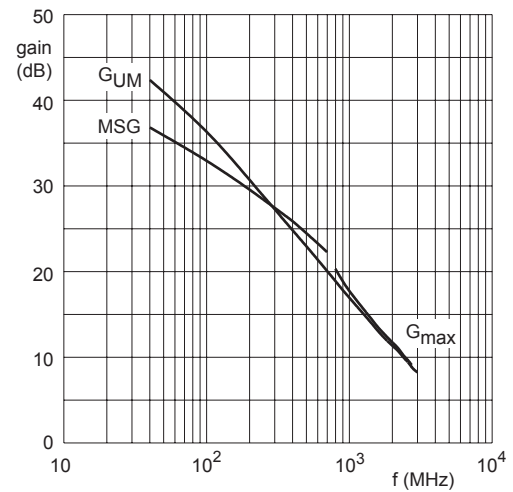

$I_C = 40\text{ mA}$; $V_{CE} = 8\text{ V}$.
 G_{UM} = maximum unilateral power gain;
MSG = maximum stable gain; G_{max} = maximum available gain.

Fig.8 Gain as a function of frequency.

NPN 9GHz Wideband Transistor

BFG540

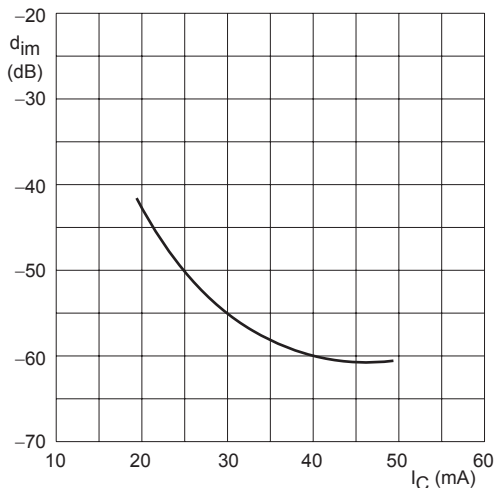

Fig.9 Intermodulation distortion as a function of collector current.

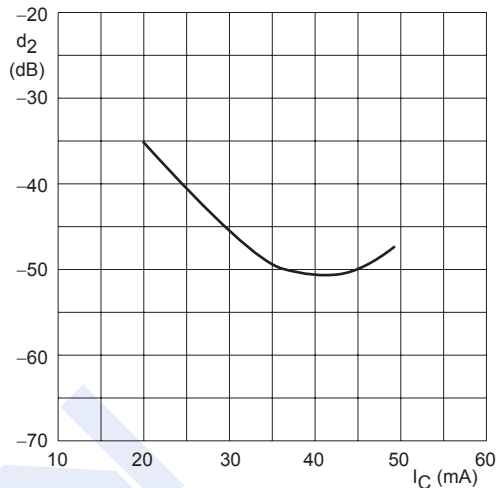
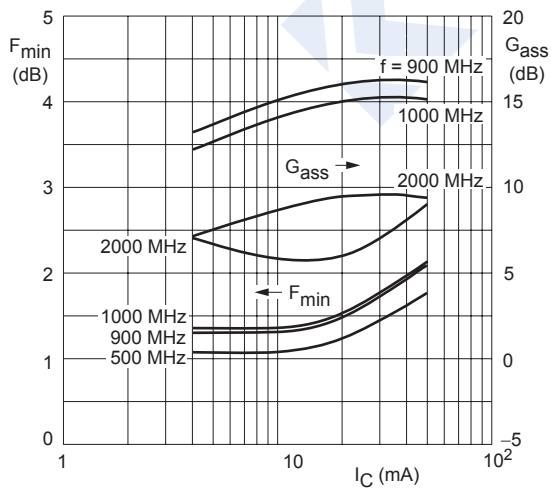
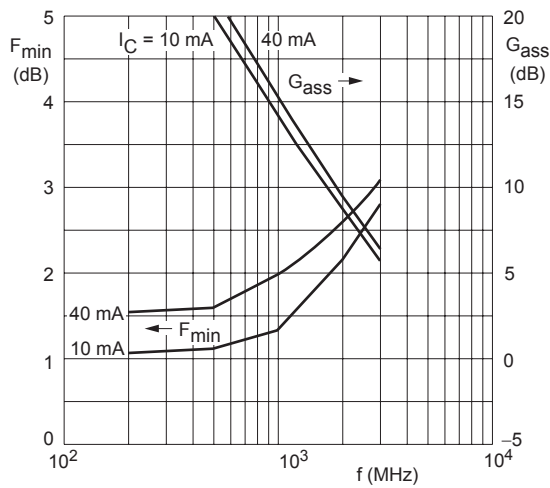

Fig.10 Second order intermodulation distortion as a function of collector current.



$V_{CE} = 8 V.$

Fig.11 Minimum noise figure and associated available gain as functions of collector current.



$V_{CE} = 8 V.$

Fig.12 Minimum noise figure and associated available gain as functions of frequency.

NPN 9GHz Wideband Transistor BFG540

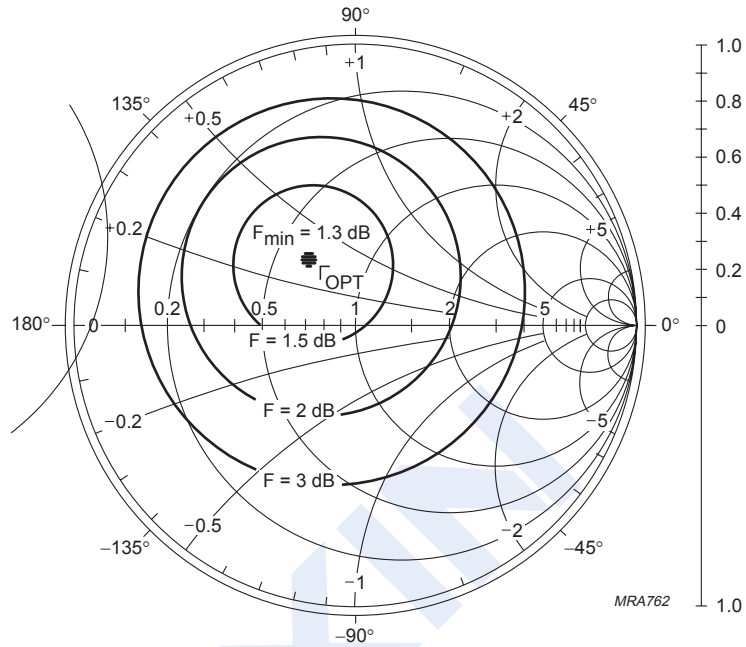

$I_C = 10 \text{ mA}$; $V_{CE} = 8 \text{ V}$; $Z_o = 50 \Omega$; $f = 900 \text{ MHz}$.

Fig.13 Noise circle figure.

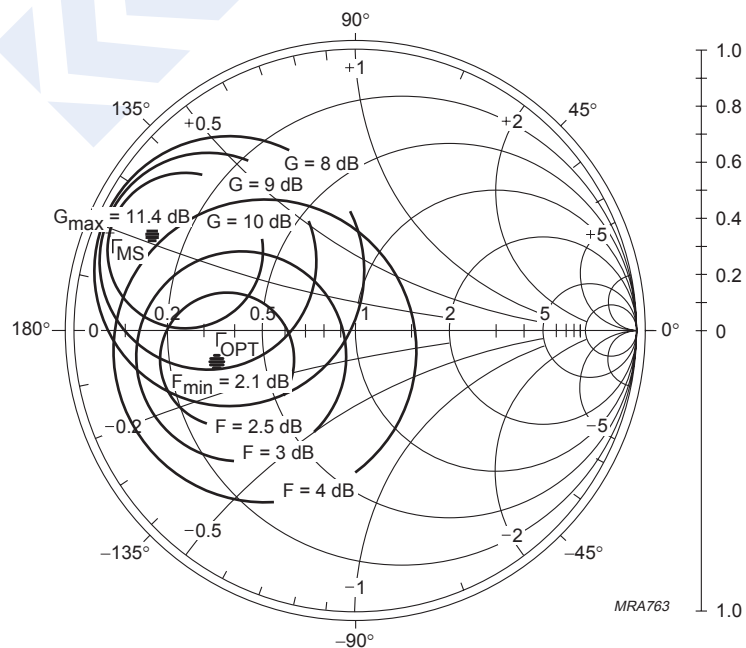

$I_C = 10 \text{ mA}$; $V_{CE} = 8 \text{ V}$; $Z_o = 50 \Omega$; $f = 2 \text{ GHz}$.

Fig.14 Noise circle figure.

NPN 9GHz Wideband Transistor BFG540

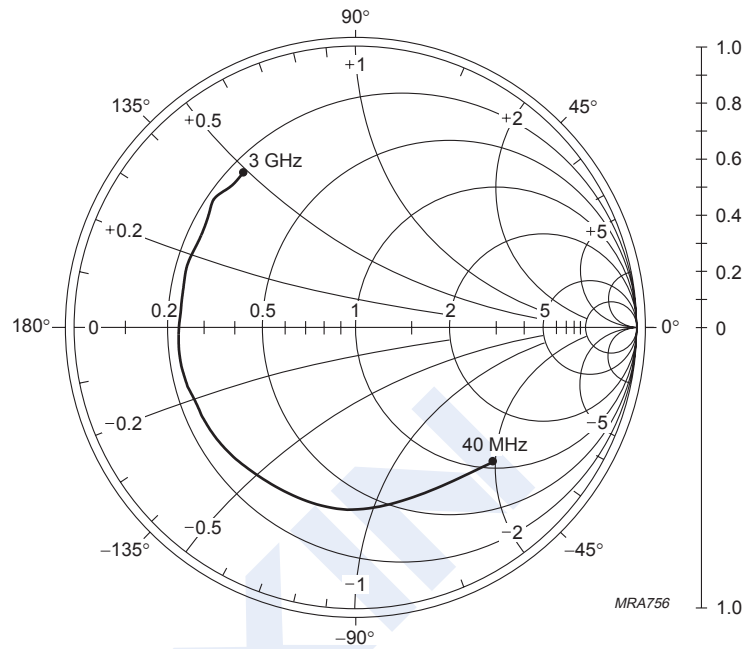

$I_C = 40 \text{ mA}$; $V_{CE} = 8 \text{ V}$; $Z_o = 50 \Omega$.

Fig.15 Common emitter input reflection coefficient (s_{11}).

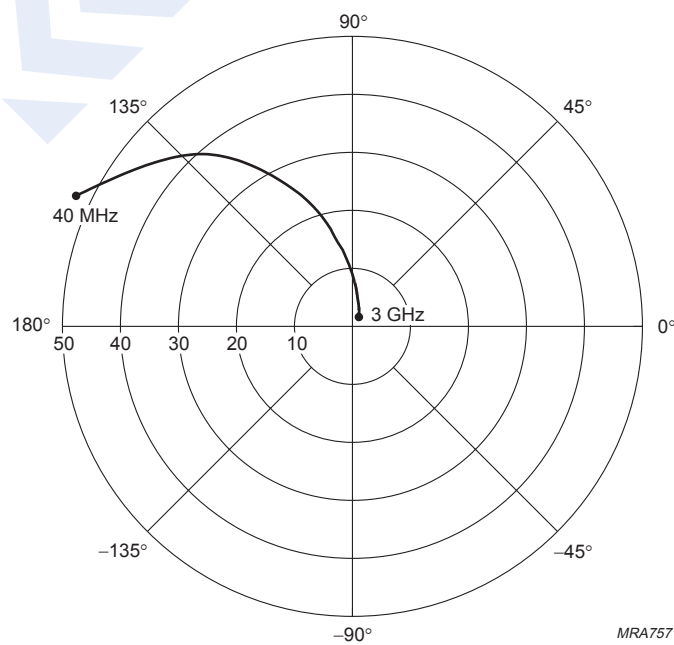

$I_C = 40 \text{ mA}$; $V_{CE} = 8 \text{ V}$.

Fig.16 Common emitter forward transmission coefficient (s_{21}).

NPN 9GHz Wideband Transistor

BFG540

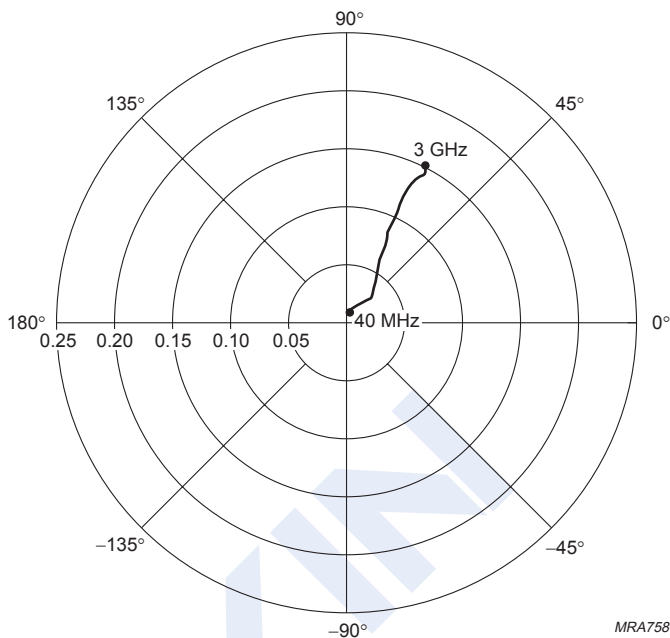

$I_C = 40 \text{ mA}; V_{CE} = 8 \text{ V}.$

Fig.17 Common emitter reverse transmission coefficient (s_{12}).

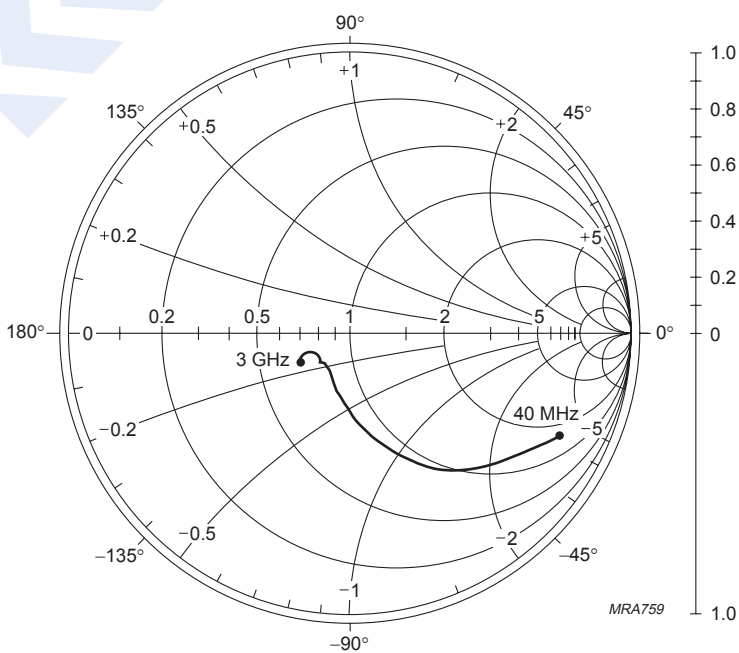

$I_C = 40 \text{ mA}; V_{CE} = 8 \text{ V}; Z_o = 50 \Omega.$

Fig.18 Common emitter output reflection coefficient (s_{22}).