

## PNP Transistors

### 2SB1266

#### ■ Features

- Suitable for sets whose height is restricted
- Complementary to 2SD1902

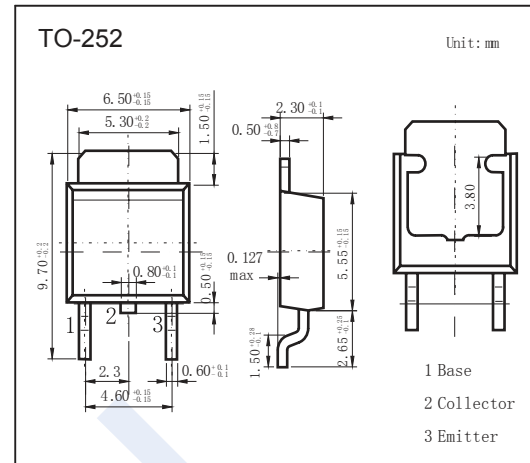

#### ■ Absolute Maximum Ratings $T_a = 25^\circ\text{C}$

Parameter	Symbol	Rating	Unit
Collector - Base Voltage	$V_{CB0}$	-60	V
Collector - Emitter Voltage	$V_{CE0}$	-60	
Emitter - Base Voltage	$V_{EB0}$	-6	
Collector Current - Continuous	$I_C$	-3	A
Collector Current - Pulse	$I_{CP}$	-8	
Collector Power Dissipation	$P_C$	30	W
$T_c = 25^\circ\text{C}$ $T_a = 25^\circ\text{C}$		1.65	
Junction Temperature	$T_J$	150	$^\circ\text{C}$
Storage Temperature range	$T_{stg}$	-55 to 150	

#### ■ Electrical Characteristics $T_a = 25^\circ\text{C}$

Parameter	Symbol	Test Conditions	Min	Typ	Max	Unit
Collector-base breakdown voltage	$V_{CB0}$	$I_C = -1\text{ mA}, I_E = 0$	-60			V
Collector-emitter breakdown voltage	$V_{CE0}$	$I_C = -5\text{ mA}, R_{BE} = \infty$	-60			
Emitter-base breakdown voltage	$V_{EB0}$	$I_E = -1\text{ mA}, I_C = 0$	-6			
Collector-base cut-off current	$I_{CBO}$	$V_{CB} = -50\text{ V}, I_E = 0$			-100	$\mu\text{A}$
Emitter cut-off current	$I_{EBO}$	$V_{EB} = -5\text{ V}, I_C = 0$			-100	
Collector-emitter saturation voltage	$V_{CE(sat)}$	$I_C = -2\text{ A}, I_B = -200\text{ mA}$		-0.4	-1	V
Base-emitter saturation voltage	$V_{BE(sat)}$	$I_C = -2\text{ A}, I_B = -200\text{ mA}$			-1.2	
Base-emitter voltage	$V_{BE}$	$V_{CE} = -5\text{ V}, I_C = -500\text{ mA}$			-1	
DC current gain	$h_{FE}$	$V_{CE} = -5\text{ V}, I_C = -500\text{ mA}$	70		280	
		$V_{CE} = -5\text{ V}, I_C = -3\text{ A}$	20			
Collector output capacitance	$C_{ob}$	$V_{CB} = -10\text{ V}, I_E = 0, f = 1\text{ MHz}$		60		$\text{pF}$
Transition frequency	$f_T$	$V_{CE} = -5\text{ V}, I_C = -500\text{ mA}$		8		MHz

#### ■ Classification of $h_{FE}(1)$

Type	2SB1266-Q	2SB1266-R	2SB1266-S
Range	70-140	100-200	140-280

### PNP Transistors

### 2SB1266

■ Typical Characteristics

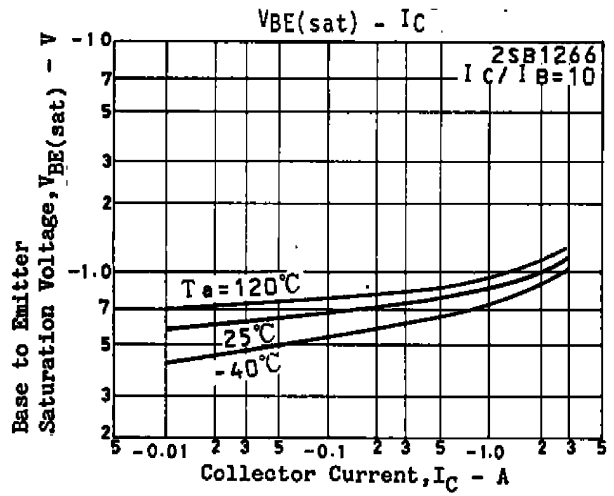
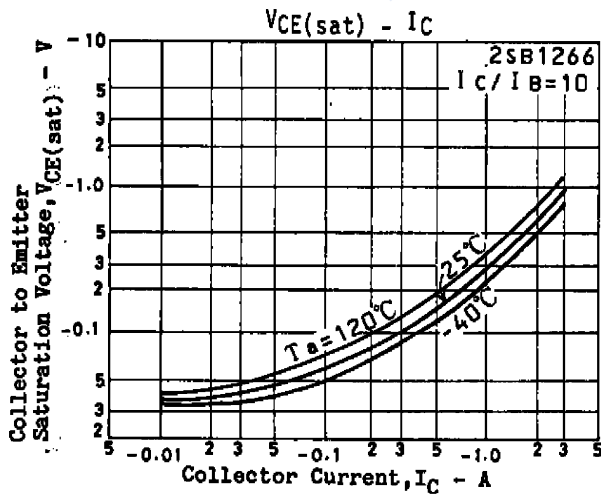
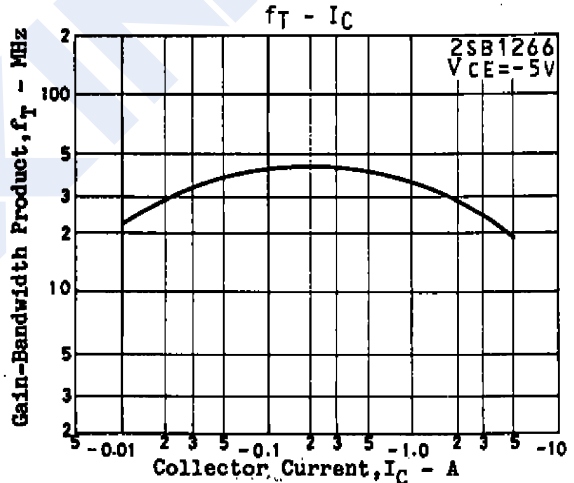
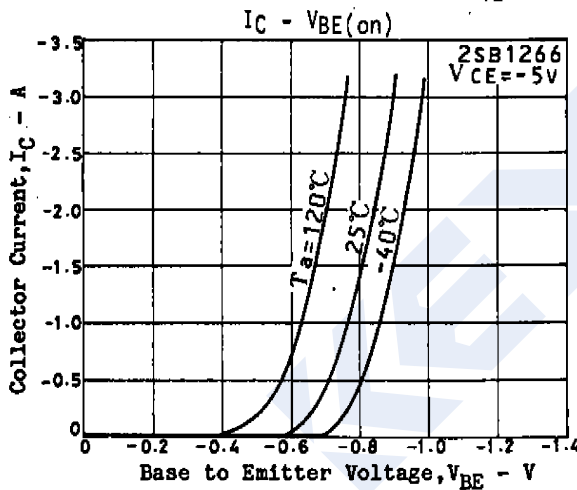
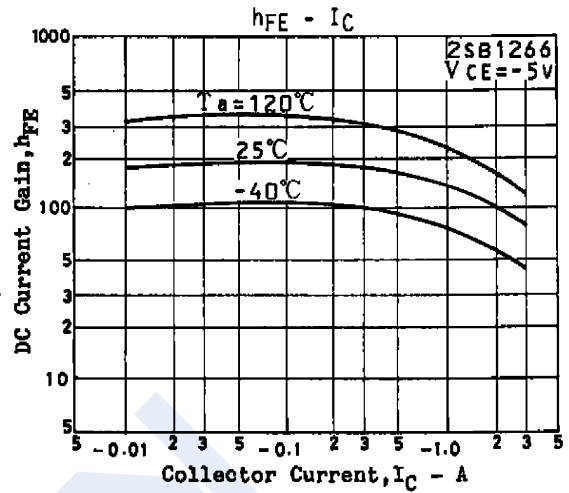
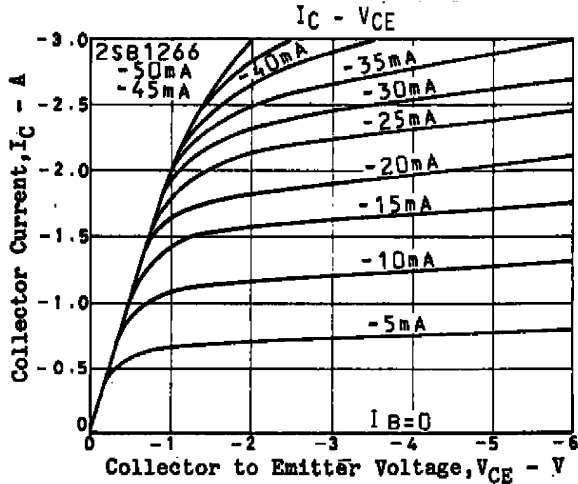

## PNP Transistors

## 2SB1266

## ■ Typical Characteristics

