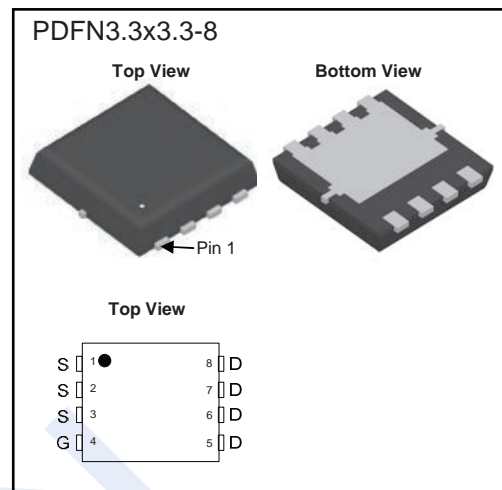
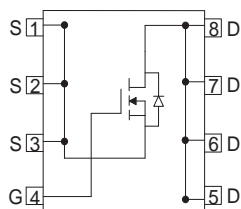

N-Channel MOSFET

2KK5136DFN

■ Features

- $V_{DS} (V) = 40 V$
- $I_D = 50 A$
- $R_{DS(ON)} (at V_{GS} = 10 V) = 6 m\Omega$
- $R_{DS(ON)} (at V_{GS} = 4.5 V) < 10.5 m\Omega$
- Low FOM $R_{DS(ON)} \times Q_G$

■ Absolute Maximum Ratings ($T_C = 25^\circ C$ unless otherwise noted)

Parameter	Symbol	Rating	Unit
Drain-Source Voltage	V_{DS}	40	V
Gate-Source Voltage	V_{GS}	± 20	
Continuous Drain Current (Note 1)	I_D	$T_C = 25^\circ C$	50
		$T_C = 100^\circ C$	32
Pulsed Drain Current (Note 2)	I_{DM}	184	A
Single Pulse Avalanche Energy (Note 3)	E_{AS}	45.5	mJ
Power Dissipation	P_D	28	W
Thermal Resistance. Junction to Ambient	$R_{\theta JA}$	60	$^\circ C/W$
Thermal Resistance. Junction- to-Case	$R_{\theta JC}$	4.5	
Junction Temperature	T_J	150	$^\circ C$
Storage Temperature Range	T_{stg}	-55 to 150	

Notes:

1. Drain current limited by maximum junction temperature
2. Repetitive Rating : Pulse width limited by maximum junction temperature
3. $L = 0.5 mH$, $V_{DD} = 20V$, $I_{AS} = 13.5 A$, $R_G = 25 \Omega$, Starting $T_J = 25^\circ C$

N-Channel MOSFET

2KK5136DFN

■ Electrical Characteristics (T_c = 25°C unless otherwise specified)

Parameter	Symbol	Test Conditions	Min	Typ	Max	Unit
Off Characteristics						
Drain-Source Breakdown Voltage	BV _{DSS}	I _D = 250 μA, V _{GS} = 0V	40			V
Zero Gate Voltage Drain Current	I _{DSS}	V _{DS} = 40 V, V _{GS} = 0 V			1	μA
		V _{DS} = 40 V, V _{GS} = 0 V, T _J = 85°C			30	
Gate to Source Leakage Current	I _{GSS}	V _{DS} = 0 V, V _{GS} = ±20 V			±100	nA
On Characteristics						
Gate to Source Threshold Voltage	V _{GS(th)}	V _{DS} = V _{GS} , I _D = 250μA	1.1	1.6	2.2	V
Static Drain-Source On-Resistance	R _{DS(on)}	V _{GS} = 10 V, I _D = 30 A			6	mΩ
		V _{GS} = 4.5 V, I _D = 20 A			10.5	
Forward Transconductance	g _{FS}	V _{DS} = 5 V, I _D = 30 A	30			S
Dynamic Characteristics						
Input Capacitance	C _{iss}	V _{GS} = 0 V, V _{DS} = 20 V, f = 1 MHz		842		pF
Output Capacitance	C _{oss}			321		
Reverse Transfer Capacitance	C _{rss}			13		
Switching Characteristics						
Turn-On DelayTime	t _{d(on)}	V _{DD} = 20 V, R _L = 1 Ω, V _{GS} = 10 V, R _G = 1.6 Ω (Note 4,5)		5.5		ns
Turn-On Rise Time	t _r			49.5		
Turn-Off DelayTime	t _{d(off)}			18		
Turn-Off Fall Time	t _f			5.5		
Total Gate Charge	Q _g	V _{DD} = 20 V, V _{GS} = 10V, I _D = 20 A (Note 4,5)		13.5		nC
Gate Source Charge	Q _{gs}			2.4		
Gate Drain Charge	Q _{gd}			2.6		
Drain-Source Diode Characteristics						
Body Diode Reverse Recovery Time	t _{rr}	V _{DD} = 20 V, I _D = 20 A, di/dt = 100 A/μS		28.6		ns
Body Diode Reverse Recovery Charge	Q _{rr}			15		nC
Maximum Body-Diode Continuous Current	I _S			46		A
Maximum Body-Diode Current (Pulsed)	I _{SM}			184		A
Diode Forward Voltage	V _{SD}	V _{GS} = 0 V, I _S = 20 A			1.2	V

Notes:

4. I_{SD} ≤ I_{Max}, di/dt = 100A/μs, V_{DD} ≤ BV_{DSS}, Staring T_J = 25°C
5. Pulse Test : Pulse width ≤ 300us, Duty cycle ≤ 2%
6. Essentially independent of operating temperature

■ Marking

Marking	K5136 KC***
---------	----------------

N-Channel MOSFET

2KK5136DFN

■ Typical Electrical And Thermal Characteristics

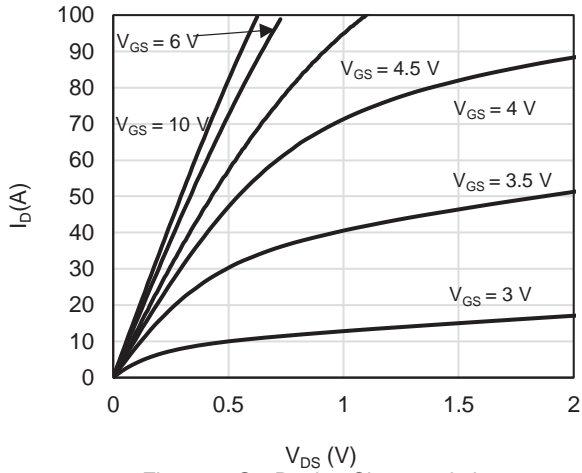

Figure 1: On-Region Characteristics

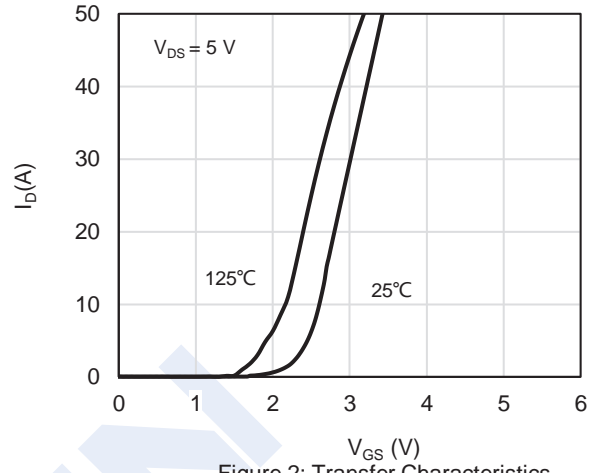

Figure 2: Transfer Characteristics

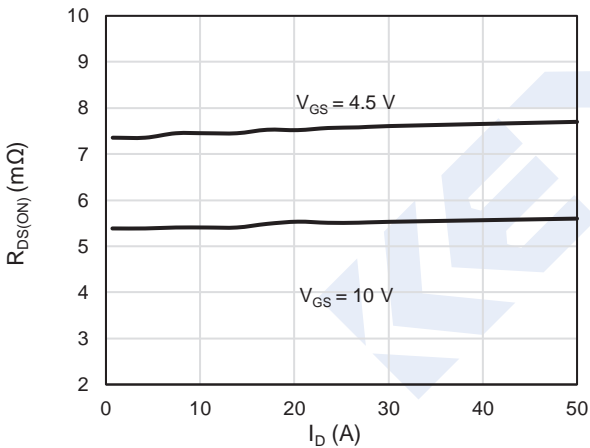

Figure 3: On-Resistance vs. Drain Current and Gate Voltage

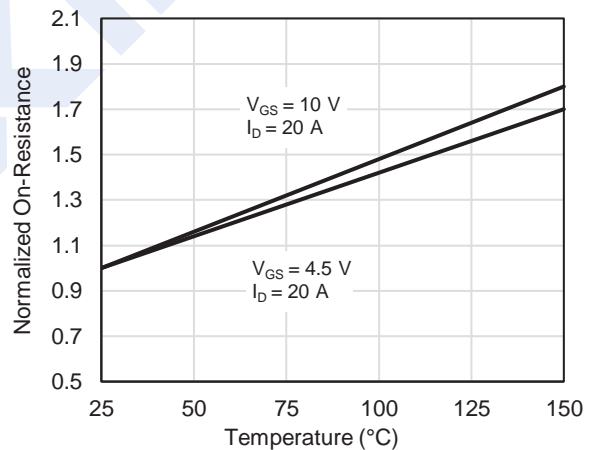

Figure 4: On-Resistance vs. Junction Temperature

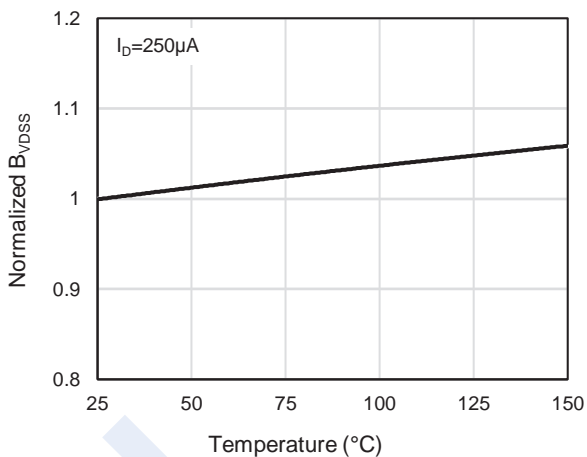

Figure 5: Breakdown Voltage vs. Junction Temperature

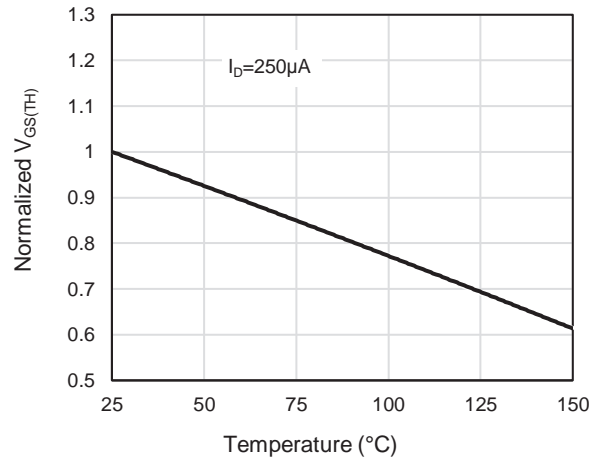

Figure 6: Threshold Voltage vs. Junction Temperature

N-Channel MOSFET

2KK5136DFN

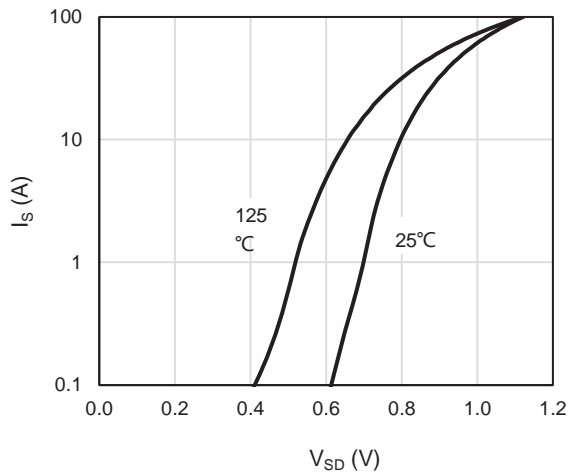

Figure 7: Body-Diode Characteristics

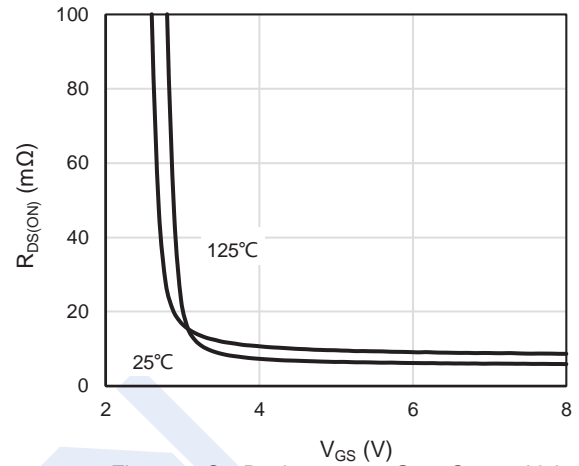

Figure 8: On-Resistance vs. Gate-Source Voltage

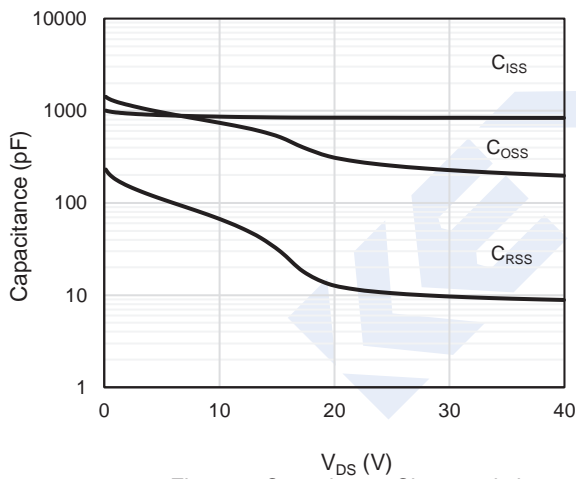

Figure 9: Capacitance Characteristics

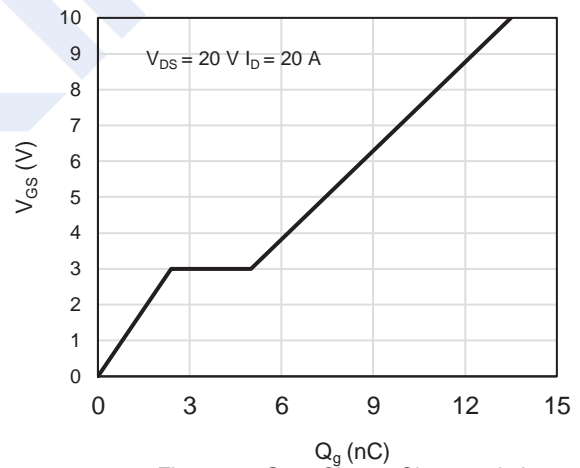

Figure 10: Gate-Charge Characteristics

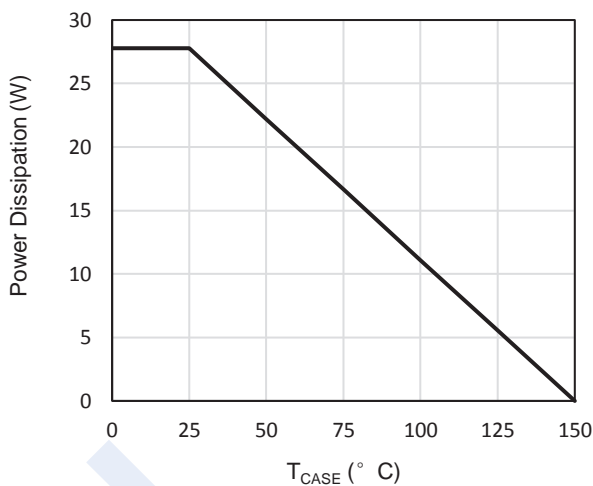

Figure 11: Power De-rating

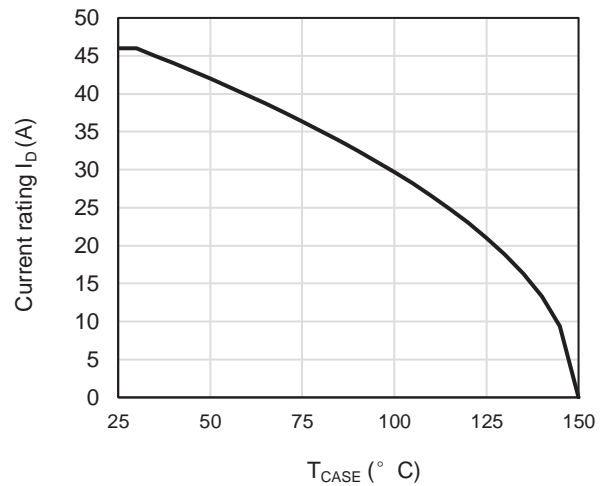

Figure 12: Current De-rating

N-Channel MOSFET

2KK5136DFN

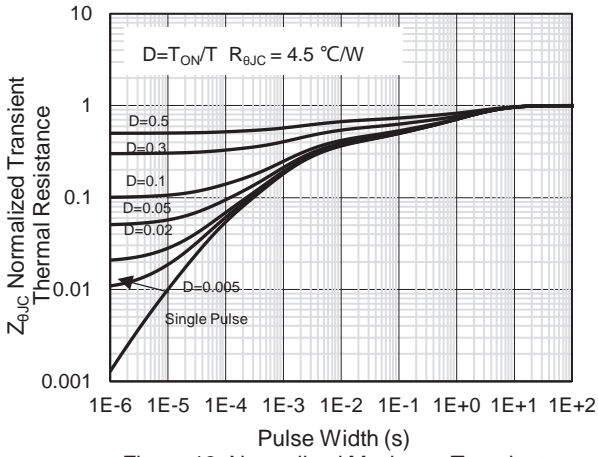

Figure 13: Normalized Maximum Transient Thermal Impedance

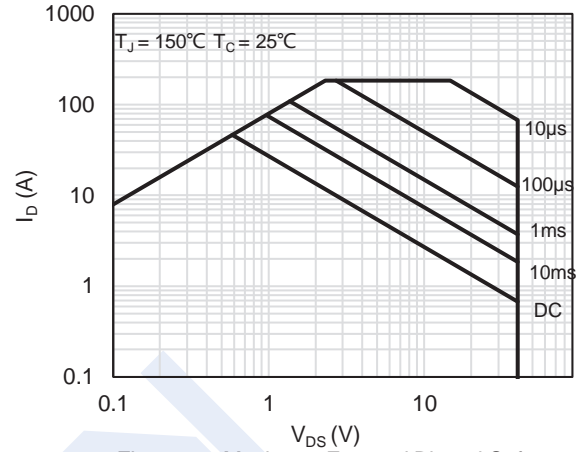

Figure 14: Maximum Forward Biased Safe Operating Area

N-Channel MOSFET

2KK5136DFN

■ Test Circuit and Waveform

Gate Charge Test Circuit & Waveform

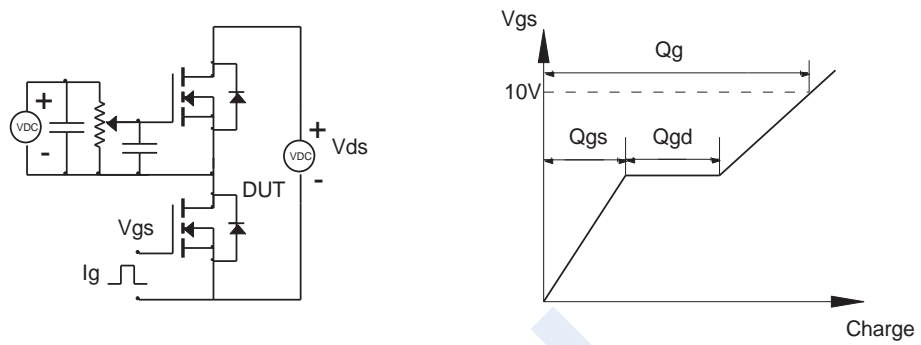

Resistive Switching Test Circuit & Waveforms

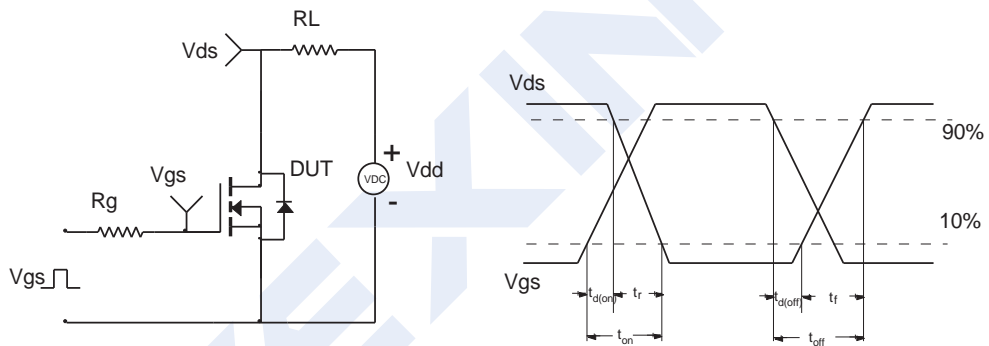

Unclamped Inductive Switching (UIS) Test Circuit & Waveforms

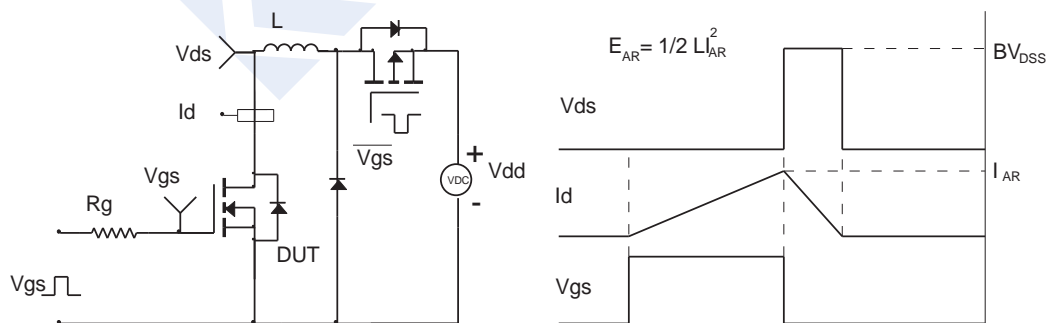

Diode Recovery Test Circuit & Waveforms

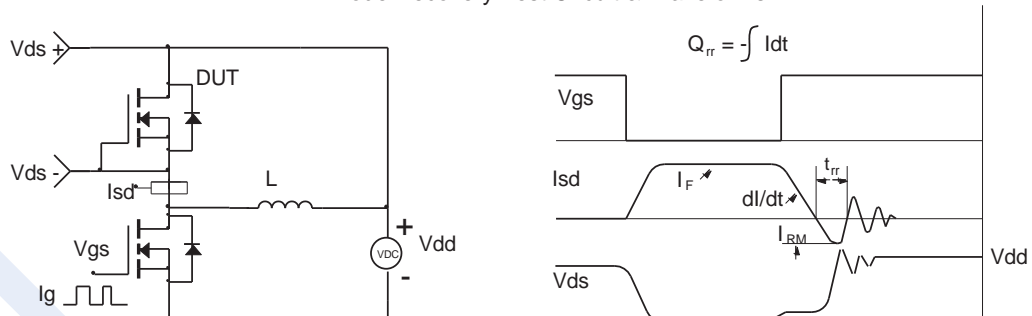

N-Channel MOSFET

2KK5136DFN

■ PDFN3.3x3.3-8 Package Outline Dimensions

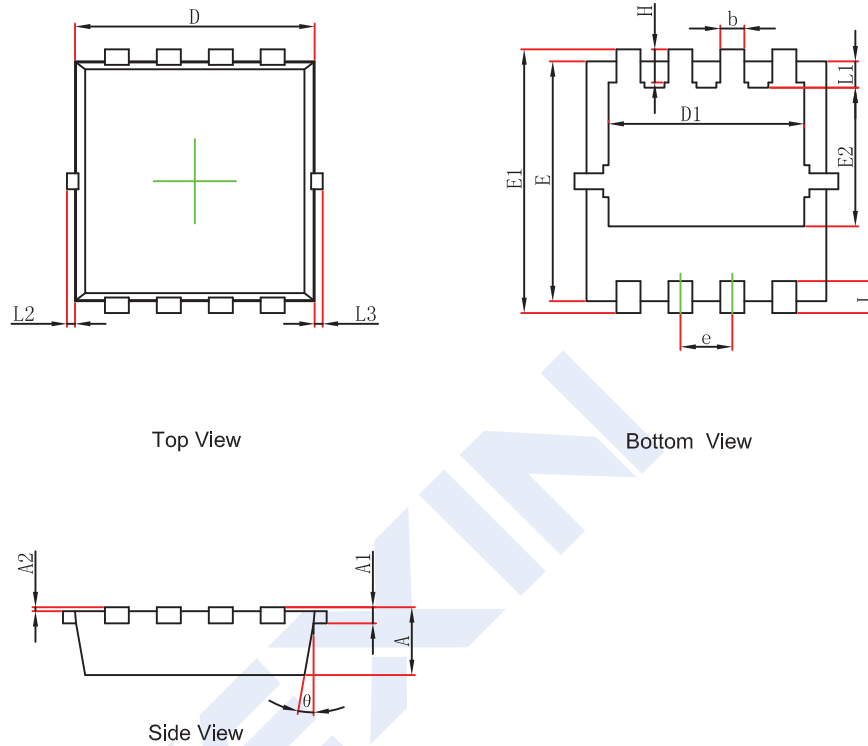

Symbol	Dimensions In Millimeters		Dimensions In Inches	
	Min.	Max.	Min.	Max.
A	0.650	0.850	0.026	0.033
A1	0.152 REF.		0.006 REF.	
A2	0~0.05		0~0.002	
D	3.050	3.250	0.114	0.122
D1	2.300	2.600	0.091	0.102
E	2.900	3.100	0.114	0.122
E1	3.150	3.450	0.124	0.136
E2	1.535	1.935	0.060	0.076
b	0.200	0.400	0.008	0.016
e	0.550	0.750	0.022	0.030
L	0.300	0.500	0.012	0.020
L1	0.180	0.480	0.007	0.019
L2	0~0.100		0~0.004	
L3	0~0.100		0~0.004	
H	0.315	0.515	0.012	0.020
θ	9°	13°	9°	13°