

Dual P-channel MOSFET

2KJ7114DFN

■ Features

- V_{DS} (V) = -20V
- I_D = -6.0A
- Low threshold voltage
- Very fast switching
- Trench MOSFET technology

DFN2X2-6

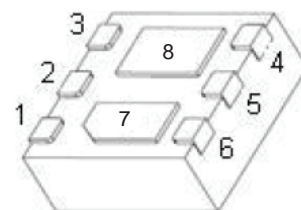

1.S1	5.G2
2.G1	6.D1
3.D2	7.D1
4.S2	8.D2

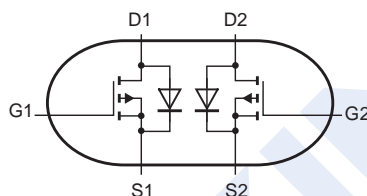
■ Absolute Maximum Ratings ($T_A = 25^\circ\text{C}$ Unless otherwise noted)

Parameter	Symbol	Rating	Unit
Drain-Source Voltage	V_{DS}	-20	V
Gate-Source Voltage	V_{GS}	± 8	
Continuous Drain Current, $t \leq 5$ s ^{*1}	I_D	-6.0	A
Pulsed Drain Current ($t_p \leq 10\mu\text{s}$)	I_{DM}	-14.4	
Power Dissipation	P_D	1210	mW
		515	
Thermal Resistance, Junction- to-Ambient	$R_{\theta JA}$	in free air ^{*2}	244
		in free air ^{*1}	104
		in free air; $t \leq 5$ s ^{*1}	64
Junction Temperature	T_J	150	$^\circ\text{C}$
Junction Storage Temperature Range	T_{stg}	-55 to 150	

*1. Device mounted on an FR4 Printed-Circuit Board (PCB), single-sided copper, tin-plated, mounting pad for drain 6 cm^2 .

*2. Device mounted on an FR4 Printed-Circuit Board (PCB), single-sided copper, tin-plated and standard footprint.

Dual P-channel MOSFET

2KJ7114DFN

■ Electrical Characteristics ($T_A = 25^\circ\text{C}$ Unless otherwise noted)

Parameter	Symbol	Test Conditions	Min	Typ	Max	Unit
Drain-Source Breakdown Voltage	V_{DSS}	$I_D = -10\mu\text{A}$, $V_{GS} = 0\text{V}$	-20			V
Zero Gate Voltage Drain Current	I_{DSS}	$V_{DS} = -20\text{V}$, $V_{GS} = 0\text{V}$			-1	μA
		$V_{DS} = -20\text{V}$, $V_{GS} = 0\text{V}$, $T_J = 150^\circ\text{C}$			-10	
Gate-Body Leakage Current	I_{GSS}	$V_{DS} = 0\text{V}$, $V_{GS} = \pm 8\text{V}$			± 100	nA
Gate Threshold Voltage	$V_{GS(th)}$	$V_{DS} = V_{GS}$, $I_D = -250\mu\text{A}$	-0.45		-0.95	V
Static Drain-Source On-Resistance	$R_{DS(on)}$	$V_{GS} = -4.5\text{V}$, $I_D = -2\text{A}$		28	40	m Ω
		$V_{GS} = -4.5\text{V}$, $I_D = -2\text{A}$, $T_J = 150^\circ\text{C}$			65	
		$V_{GS} = -2.5\text{V}$, $I_D = -1.5\text{A}$		42	65	
		$V_{GS} = -1.8\text{V}$, $I_D = -1\text{A}$		63	100	
Forward Transconductance	g_{FS}	$V_{DS} = -10\text{V}$, $I_D = -2\text{A}$		9		S
Input Capacitance	C_{iss}	$V_{GS} = 0\text{V}$, $V_{DS} = -10\text{V}$, $f = 1\text{MHz}$		804		pF
Output Capacitance	C_{oss}			95		
Reverse Transfer Capacitance	C_{rss}			66		
Total Gate Charge	Q_g	$V_{DS} = -10\text{V}$, $I_D = -2\text{A}$, $V_{GS} = -4.5\text{V}$		6.3	9.5	nC
Gate Source Charge	Q_{gs}			1.2		
Gate Drain Charge	Q_{gd}			0.9		
Turn-On Delay Time	$t_{d(on)}$	$V_{DS} = -10\text{V}$, $I_D = -2\text{A}$, $V_{GS} = -4.5\text{V}$, $R_{G(ext)} = 6\Omega$		7		ns
Turn-On Rise Time	t_r			15		
Turn-Off Delay Time	$t_{d(off)}$			41		
Turn-Off Fall Time	t_f			14		
Maximum Body-Diode Continuous Current	I_S				-1.3	A
Diode Forward Voltage	V_{SD}	$I_{SD} = -0.5\text{A}$, $V_{GS} = 0\text{V}$			-1.2	V

■ Marking

Marking	JAM
---------	-----

Dual P-channel MOSFET

2KJ7114DFN

■ Typical Characteristics

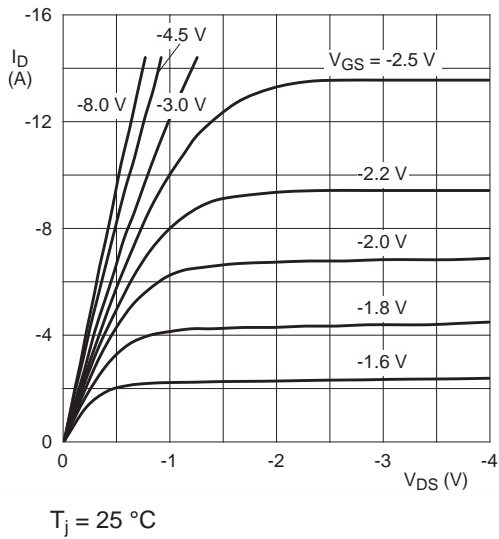

Fig. 1. Output characteristics: drain current as a function of drain-source voltage; typical values

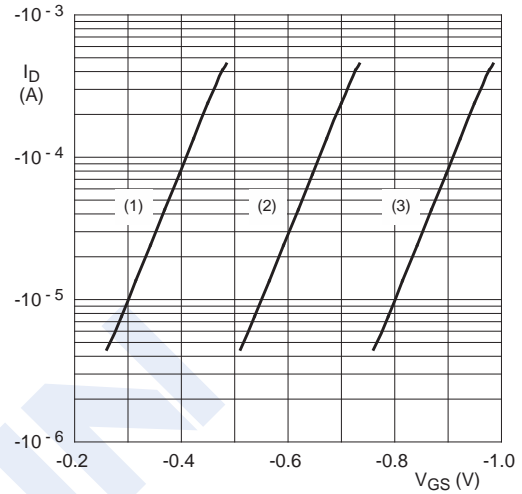

Fig. 2. Sub-threshold drain current as a function of gate-source voltage
 (1) minimum values
 (2) typical values
 (3) maximum values

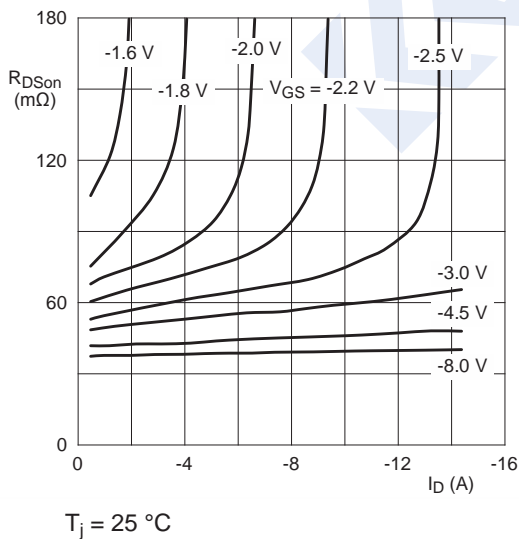

Fig. 3. Drain-source on-state resistance as a function of drain current; typical values

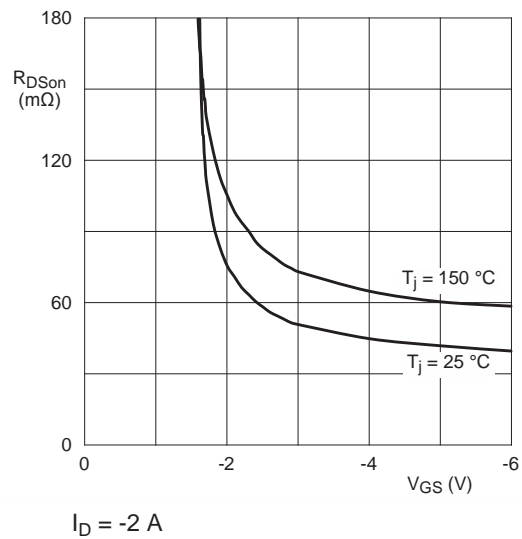
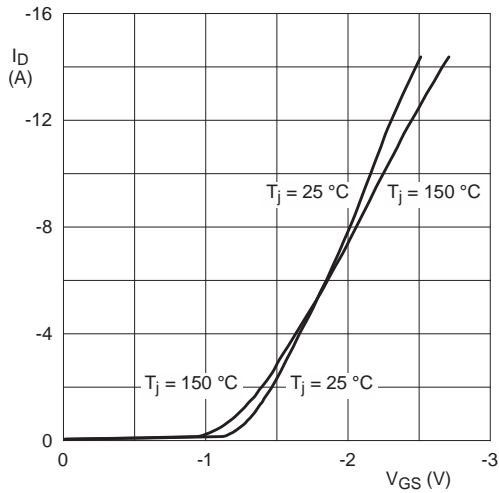

Fig. 4. Drain-source on-state resistance as a function of gate-source voltage; typical values

Dual P-channel MOSFET

2KJ7114DFN



$$V_{DS} > I_D \times R_{DSon}$$

Fig. 5. Transfer characteristics: drain current as a function of gate-source voltage; typical values

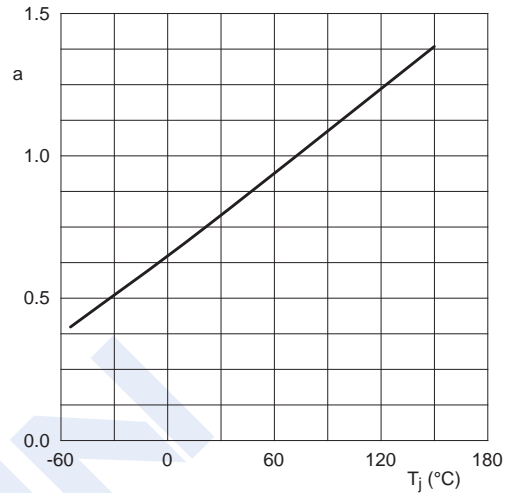
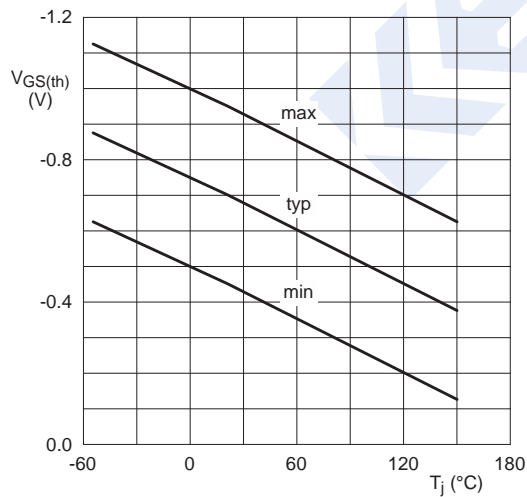

Fig. 6. Normalized drain-source on-state resistance as a function of junction temperature; typical values

$$a = \frac{R_{DSon}}{R_{DSon(25^\circ C)}}$$



$$I_D = -0.25 \text{ mA}; V_{DS} = V_{GS}$$

Fig. 7. Gate-source threshold voltage as a function of junction temperature

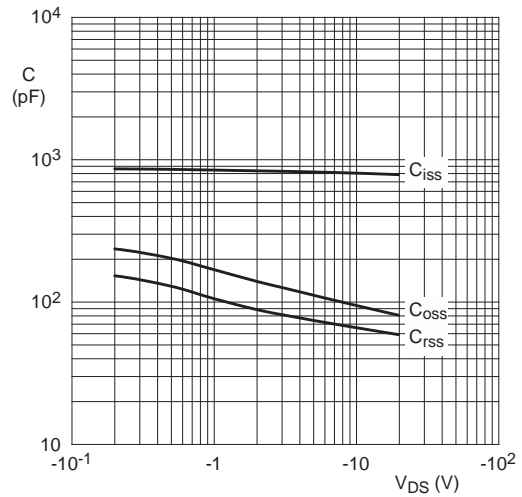

$$f = 1 \text{ MHz}; V_{GS} = 0 \text{ V}$$

Fig. 8. Input, output and reverse transfer capacitances as a function of drain-source voltage; typical values

Dual P-channel MOSFET

2KJ7114DFN

■ DFN2X2-6 Package Outline Dimensions

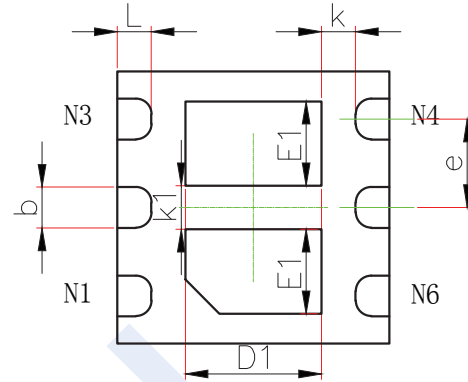
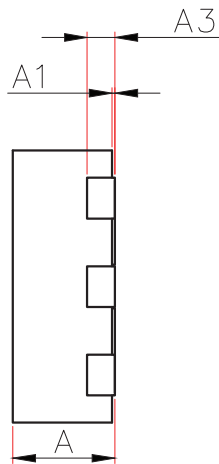
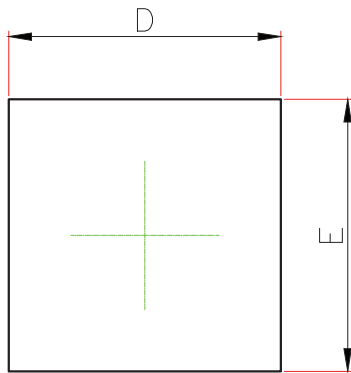

Symbol	Dimensions In Millimeter		Dimensions In Inches	
	MIN.	MAX.	MIN.	MAX.
A	0.450	0.650	0.019	0.026
A1	0.000	0.050	0.000	0.002
A3	0.203REF.		0.008REF.	
D	1.900	2.100	0.075	0.083
E	1.900	2.100	0.075	0.083
D1	0.900	1.100	0.035	0.043
E1	0.520	0.720	0.020	0.028
b	0.250	0.350	0.010	0.014
e	0.625TYP.		0.025TYP.	
k	0.200MIN.		0.008MIN.	
k1	0.320REF.		0.013REF.	
L	0.200	0.300	0.008	0.012

■ Suggested Pad Layout

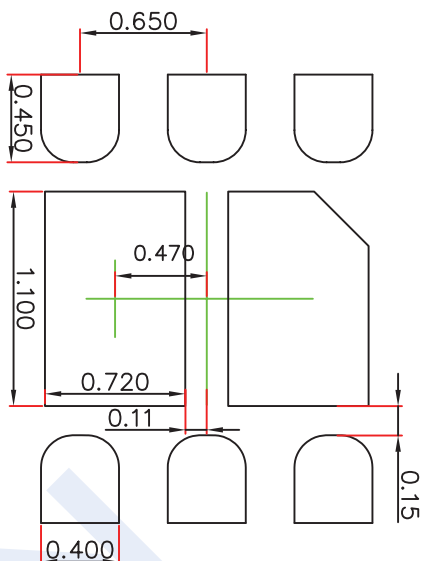

Note:

1. Controlling dimension: in millimeters,
2. General tolerance: $\pm 0.050\text{mm}$,
3. The pad layout is for reference purposes only.