

P-Channel MOSFET

2KJ7003

■ Features

- $V_{DS} = -30V$
- $I_D = -12A$
- $R_{DS(on)} < 15m\Omega @ V_{GS} = -10V$
- $R_{DS(on)} < 22m\Omega @ V_{GS} = -4.5V$

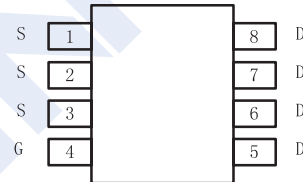
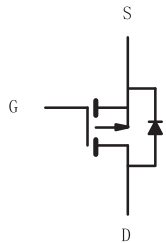
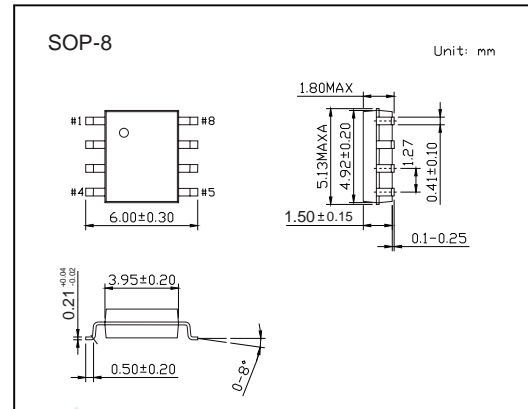

Top View

■ Absolute Maximum Ratings $T_a = 25^\circ C$

Parameter	Symbol	Rating	Unit
Drain-Source Voltage	V_{DS}	-30	V
Gate-Source Voltage	V_{GS}	± 20	
Continuous Drain Current	I_D	-12	A
Pulsed Drain Current	I_{DM}	-50	
Avalanche Current with Single Pulse(L=0.1mH)	I_{AS}	-15	
Avalanche Energy with Single Pulse(L=0.1mH)	E_{AS}	16	mJ
Maximum Power Dissipation	P_D	2.5	W
Maximum Junction-to-Ambient	R_{thJA}	50	$^\circ C/W$
Operating Junction and Storage Temperature Range	T_J, T_{stg}	-55 to 150	$^\circ C$

P-Channel MOSFET

2KJ7003

■ Electrical Characteristics ($T_J = 25^\circ\text{C}$, unless otherwise noted)

Parameter	Symbol	Test Conditions	Min	Typ ^a	Max	Unit
Drain-Source Breakdown Voltage	V_{DS}	$I_D = -250\mu\text{A}$, $V_{GS} = 0\text{V}$	-30			V
Zero Gate Voltage Drain Current	I_{DSS}	$V_{DS} = -24\text{V}$, $V_{GS} = 0\text{V}$			-1	μA
Gate-Body Leakage Current	I_{GSS}	$V_{DS} = 0\text{V}$, $V_{GS} = \pm 20\text{V}$			± 100	nA
Gate Threshold Voltage	$V_{GS(th)}$	$V_{DS} = V_{GS}$, $I_D = -250\mu\text{A}$	-1		-3	V
Static Drain-Source On-Resistance ^b	$R_{DS(on)}$	$V_{GS} = -10\text{V}$, $I_D = -12\text{A}$			15	m Ω
		$V_{GS} = -4.5\text{V}$, $I_D = -6.7\text{A}$			22	
		$V_{GS} = -10\text{V}$, $I_D = -12\text{A}$, $T_J = 125^\circ\text{C}$			20	
On State Drain Current ^b	$I_{D(ON)}$	$V_{GS} = -10\text{V}$, $V_{DS} = -5\text{V}$	-40			A
Forward Transconductance ^b	g_{FS}	$V_{DS} = -5\text{V}$, $I_D = -12\text{A}$		24		S
Input Capacitance	C_{iss}	$V_{GS} = 0\text{V}$, $V_{DS} = -15\text{V}$, $f = 1\text{MHz}$		1604		pF
Output Capacitance	C_{oss}			408		
Reverse Transfer Capacitance	C_{rss}			202		
Total Gate Charge	Q_g			17	24	
Gate Source Charge	Q_{gs}	$V_{GS} = -5\text{V}$, $V_{DS} = -15\text{V}$, $I_D = -12\text{A}$		5		
Gate Drain Charge	Q_{gd}			6		
Turn-On Delay Time ^c	$t_{d(on)}$	$V_{DD} = -15\text{V}$, $I_D = -1\text{A}$, $V_{GS} = -10\text{V}$, $R_{GEN} = 6\Omega$		13	23	ns
Turn-On Rise Time ^c	t_r			13.5	24	
Turn-Off Delay Time ^c	$t_{d(off)}$			42	68	
Turn-Off Fall Time ^c	t_f			25	40	
Maximum Body-Diode Pulsed Current	I_S				-2.1	A
Diode Forward Voltage ^b	V_{SD}	$I_S = -2.1\text{A}$, $V_{GS} = 0\text{V}$			-1.2	V

Notes:

- a. Guaranteed by design, not subject to production testing.
b. Pulse test; pulse width $\leq 300\mu\text{s}$, duty cycle $\leq 2\%$.

■ Marking

Marking	J7003
	KC****

P-Channel MOSFET

2KJ7003

■ Typical Characteristics

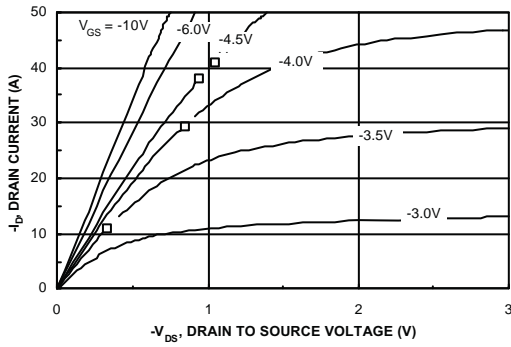

Figure 1. On-Region Characteristics.

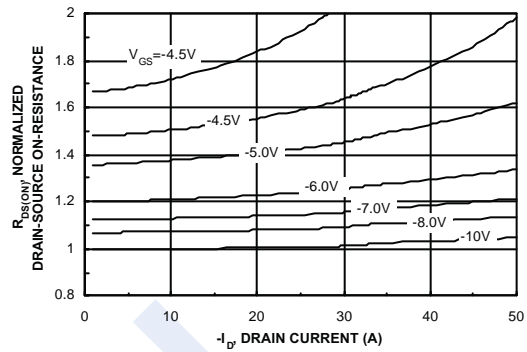

Figure 2. On-Resistance Variation with Drain Current and Gate Voltage.

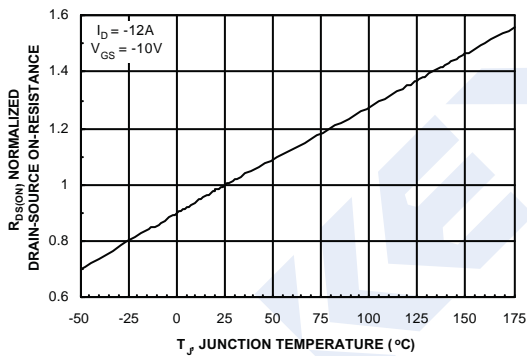

Figure 3. On-Resistance Variation with Temperature.

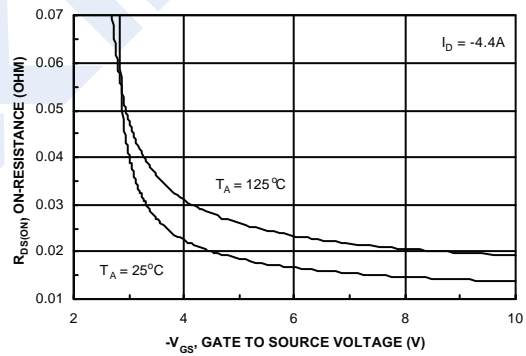

Figure 4. On-Resistance Variation with Gate-to-Source Voltage.

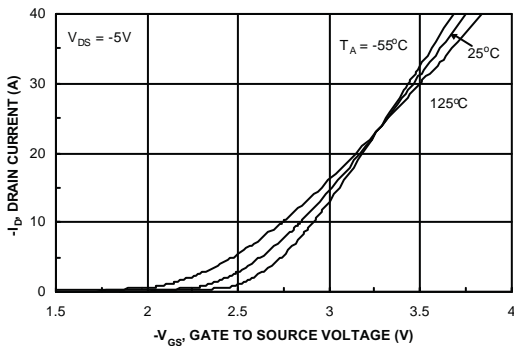

Figure 5. Transfer Characteristics.

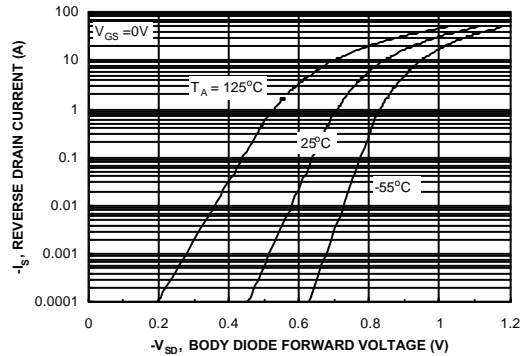

Figure 6. Body Diode Forward Voltage Variation with Source Current and Temperature.

P-Channel MOSFET

2KJ7003

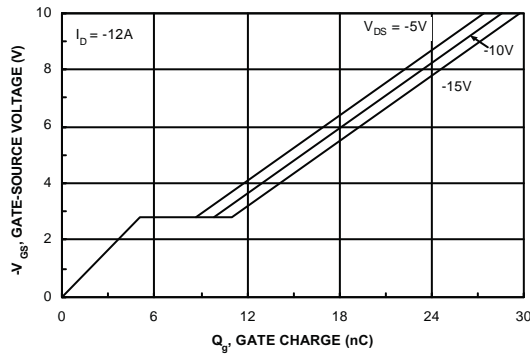

Figure 7. Gate Charge Characteristics.

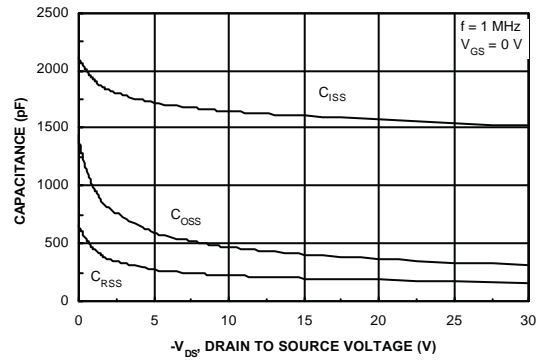

Figure 8. Capacitance Characteristics.

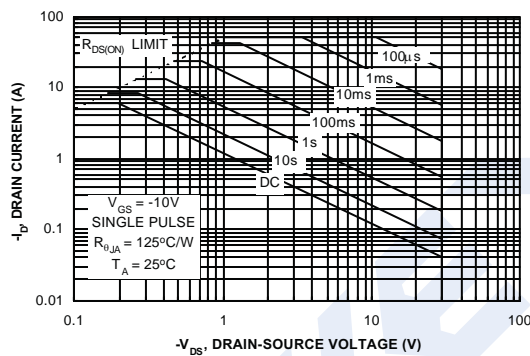

Figure 9. Maximum Safe Operating Area.

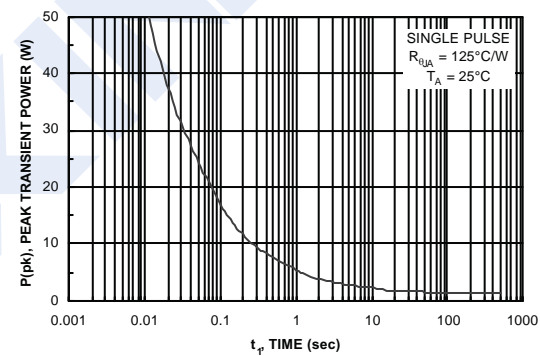

Figure 10. Single Pulse Maximum Power Dissipation.

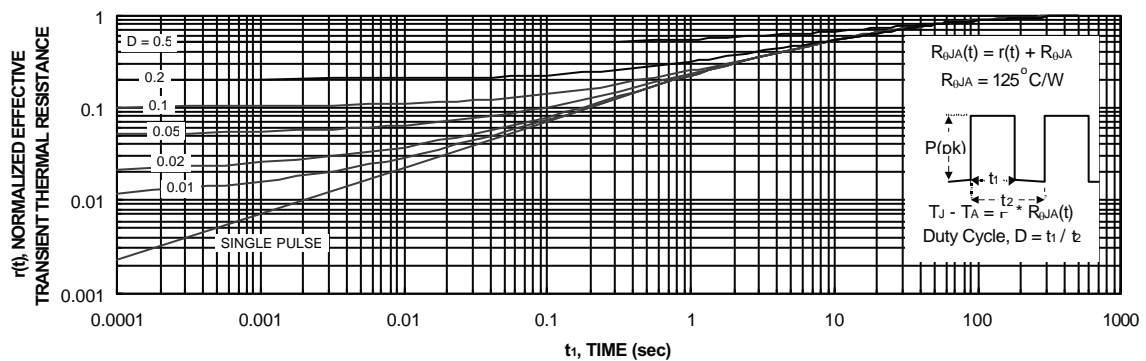

Figure 11. Transient Thermal Response Curve.

Thermal characterization performed using the conditions described in Note 1c. Transient thermal response will change depending on the circuit board design.