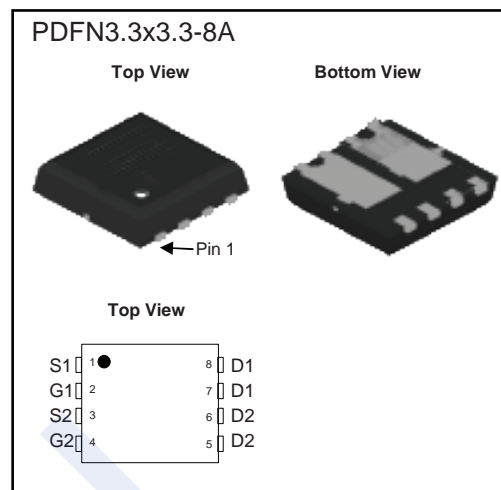
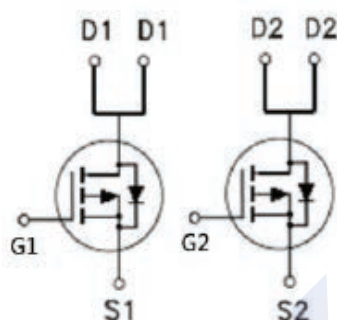

## Dual P-Channel MOSFET

## 2KJ6063DFN

## ■ Features

- $V_{DS}$  -30 V
- $I_D$  (at  $V_{GS}=-10V$ ) -29 A
- $R_{DS(ON)}$  (at  $V_{GS} = -10V$ ) < 20 m $\Omega$
- $R_{DS(ON)}$  (at  $V_{GS} = -4.5V$ ) < 29 m $\Omega$

■ Absolute Maximum Ratings ( $T_A = 25^\circ\text{C}$  unless otherwise noted.)

Parameter	Symbol	Rating	Unit	
Drain-Source Voltage	$V_{DS}$	-30	V	
Gate-Source Voltage	$V_{GS}$	$\pm 20$		
Continuous Drain Current (Note 1)	$I_D$	$T_C=25^\circ\text{C}$	A	
		$T_C=100^\circ\text{C}$		-18
Pulsed Drain Current (Note 2)	$I_{DM}$	-80		
Avalanche Current	$I_{AR}$	24		
Repetitive avalanche energy $L=0.1\text{mH}$	$E_{AR}$	29	mJ	
Power Dissipation (Note 1)	$P_D$	$T_C=25^\circ\text{C}$	W	
		$T_C=100^\circ\text{C}$		10
		$T_A=25^\circ\text{C}$		4.1
Thermal Resistance, Junction- to-Lead (Note 1)	$R_{\theta JC}$	5	$^\circ\text{C}/\text{W}$	
Thermal Resistance, Junction- to-Ambient (Note 1)	$R_{\theta JA}$	30		
Junction Temperature	$T_J$	150	$^\circ\text{C}$	
Storage Temperature Range	$T_{stg}$	-55 to 150		

Notes:

1. Surface mounted on 1.5" x 1.5" FR4 board using 1 sq in pad, 2 oz Cu.
2. Pulse width limited by maximum junction temperature.

## Dual P-Channel MOSFET

## 2KJ6063DFN

■ Electrical Characteristics ( $T_A = 25^\circ\text{C}$  unless otherwise noted)

Parameter	Symbol	Test Conditions	Min	Typ	Max	Unit
<b>OFF CHARACTERISTICS</b>						
Drain-Source Breakdown Voltage	$BV_{DSS}$	$I_D = -250\mu\text{A}$ , $V_{GS} = 0\text{V}$	-30			V
Zero Gate Voltage Drain Current	$I_{DSS}$	$V_{DS} = -30\text{V}$ , $V_{GS} = 0\text{V}$			-1	$\mu\text{A}$
		$V_{DS} = -30\text{V}$ , $V_{GS} = 0\text{V}$ , $T_J = 55^\circ\text{C}$			-5	
Gate-Body Leakage Current	$I_{GSS}$	$V_{DS} = 0\text{V}$ , $V_{GS} = \pm 20\text{V}$			$\pm 100$	nA
<b>ON CHARACTERISTICS</b>						
Gate Threshold Voltage	$V_{GS(th)}$	$V_{DS} = V_{GS}$ , $I_D = -250\mu\text{A}$	-1.0		-2.0	V
Static Drain-Source On-Resistance (Note 3)	$R_{DS(on)}$	$V_{GS} = -10\text{V}$ , $I_D = -8\text{A}$			20	m $\Omega$
		$V_{GS} = -4.5\text{V}$ , $I_D = -5\text{A}$			29	
Diode Forward Voltage (Note 3)	$V_{SD}$	$I_S = -5\text{A}$ , $V_{GS} = 0\text{V}$			-1.2	V
<b>DYNAMIC CHARACTERISTICS (Note 4)</b>						
Input Capacitance	$C_{iss}$	$V_{GS} = 0\text{V}$ , $V_{DS} = -15\text{V}$ , $f = 1\text{MHz}$		1130	2200	pF
Output Capacitance	$C_{oss}$			240		
Reverse Transfer Capacitance	$C_{rss}$			155		
Gate resistance	$R_g$	$V_{GS} = 0\text{V}$ , $V_{DS} = 0\text{V}$ , $f = 1\text{MHz}$		6		$\Omega$
Total Gate Charge	$Q_g$	$V_{DS} = -15\text{V}$ , $V_{GS} = -10\text{V}$ , $I_D = -8\text{A}$		18		nC
Gate Source Charge	$Q_{gs}$			5.5		
Gate Drain Charge	$Q_{gd}$			3.3		
<b>SWITCHING CHARACTERISTICS (Note 5)</b>						
Turn-On Delay Time	$t_{d(on)}$	$V_{GS} = -10\text{V}$ , $V_{DS} = -15\text{V}$ , $R_L = 1.8\Omega$ , $R_{GEN} = 3\Omega$		9		ns
Turn-On Rise Time	$t_r$			8		
Turn-Off Delay Time	$t_{d(off)}$			18		
Turn-Off Fall Time	$t_f$			7		
Reverse Recovery Time	$t_{rr}$	$I_F = -8\text{A}$ , $dI/dt = 500\text{A}/\mu\text{s}$		12		ns
Reverse Recovery Charge	$Q_{rr}$			26		$\mu\text{C}$

Notes:

3. Measured under pulsed conditions. Pulse width  $\leq 300\mu\text{s}$ ; duty cycle  $\leq 2\%$ .
4. For design aid only, not subject to production testing.
5. Switching characteristics are independent of operating junction temperatures.

## ■ Marking

Marking	J6063 KA****
---------	-----------------

## Dual P-Channel MOSFET

### 2KJ6063DFN

#### ■ Typical Electrical and Thermal Characteristics

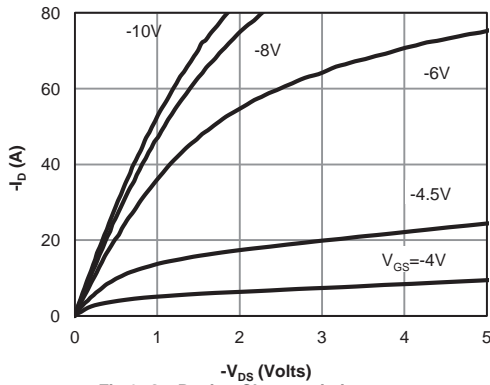

Figure 1: On-Region Characteristics

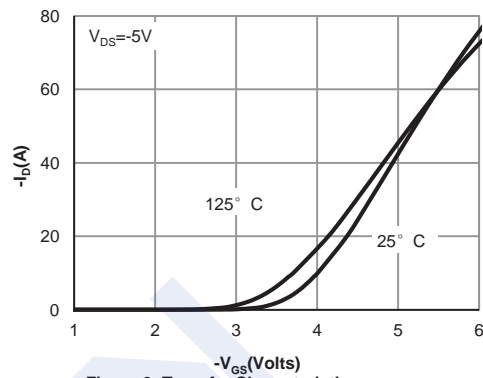

Figure 2: Transfer Characteristics

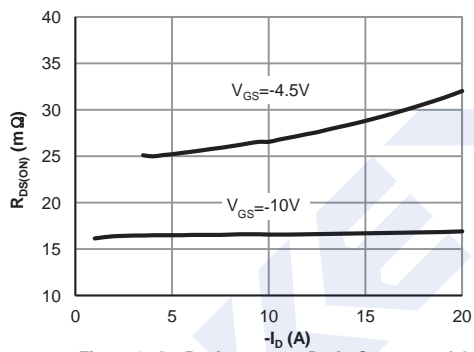

Figure 3: On-Resistance vs. Drain Current and Gate Voltage

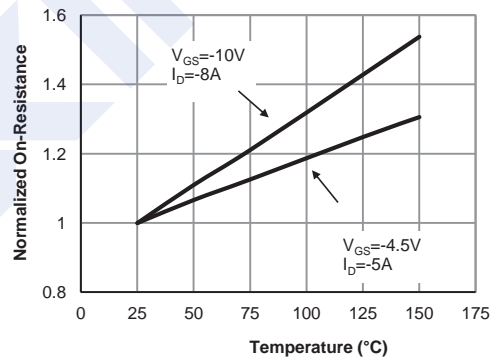

Figure 4: On-Resistance vs. Junction Temperature

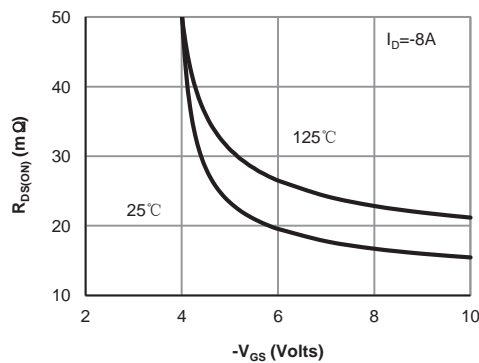

Figure 5: On-Resistance vs. Gate-Source Voltage

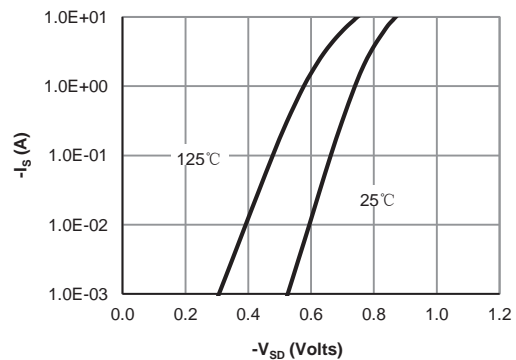

Figure 6: Body-Diode Characteristics

## Dual P-Channel MOSFET

### 2KJ6063DFN

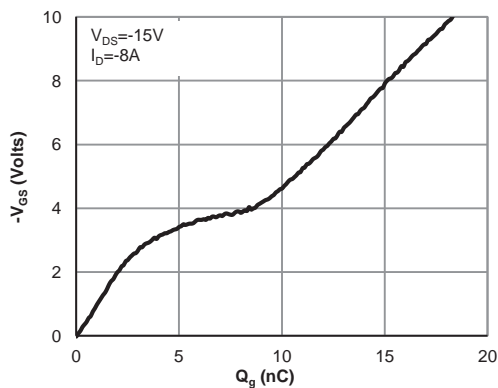

Figure 7: Gate-Charge Characteristics

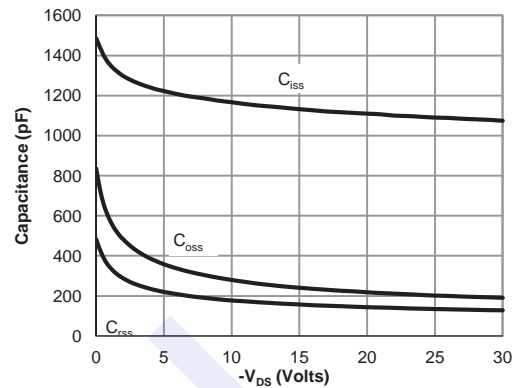

Figure 8: Capacitance Characteristics

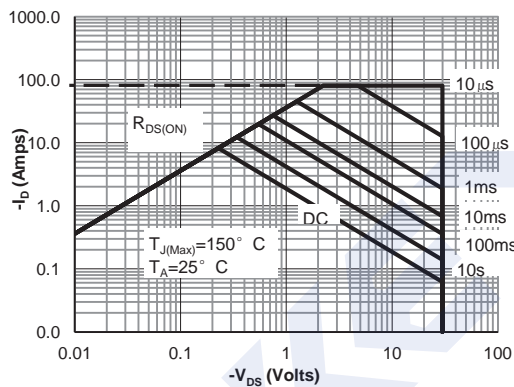

Figure 9: Maximum Forward Biased Safe Operating Area

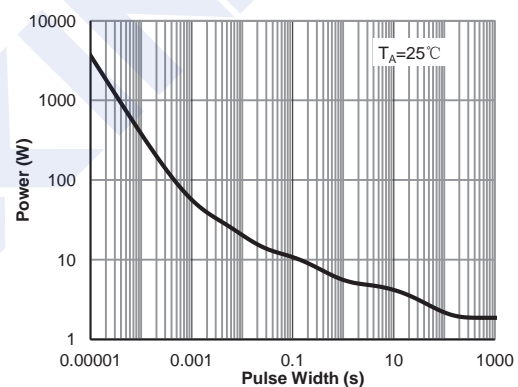

Figure 10: Single Pulse Power Rating Junction-to-Ambient

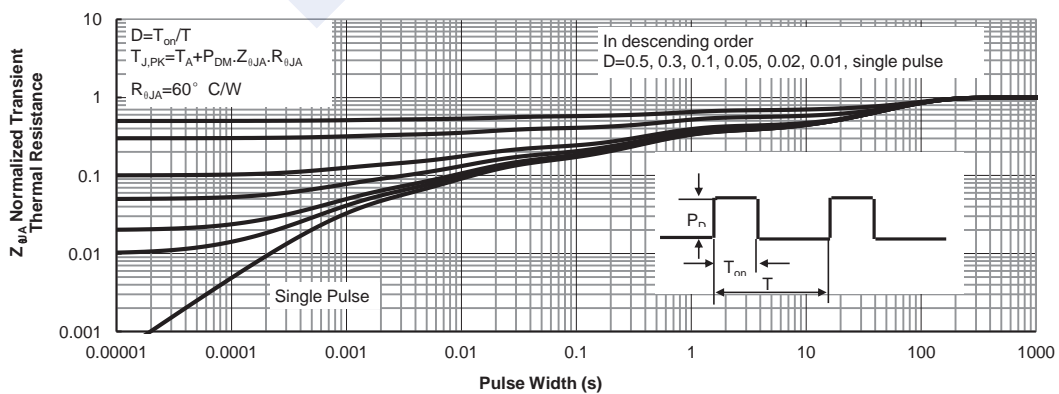

Figure 11: Normalized Maximum Transient Thermal Impedance

## Dual P-Channel MOSFET

## 2KJ6063DFN

## ■ PDFN3.3x3.3-8A Package Outline Dimensions

