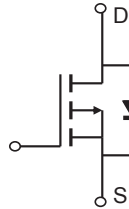
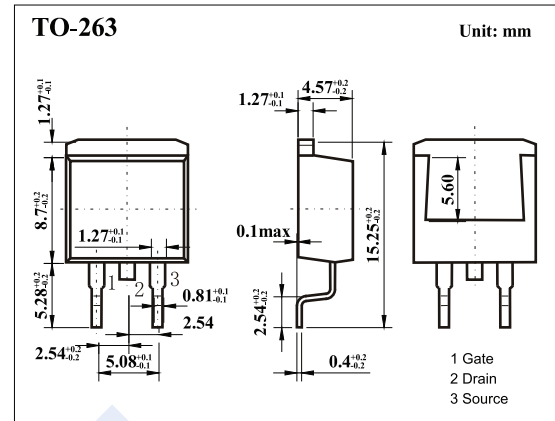

P-Channel MOSFET

2KJ6058

■ Features

- $V_{DS} (V) = -20V$
- $I_D = -105A$
- $R_{DS(on)} < 4m\Omega @ V_{GS}=4.5V$
- Low $R_{DS(on)}$ to Minimize Conduction Losses.
- Ohmic Region Good $R_{DS(on)}$ Ratio.
- Optimized Gate Charge to Minimize Switching Losses.

■ Absolute Maximum Ratings ($T_A = 25^\circ C$ Unless otherwise noted)

Parameter	Symbol	Rating	Unit	
Drain-Source Voltage	V_{DS}	-20	V	
Gate-Source Voltage	V_{GS}	± 12		
Continuous Drain Current (Note 1)	I_D	$T_C=25^\circ C$	-105	A
		$T_C=100^\circ C$	-100	
		$T_A=25^\circ C$	-42	
		$T_A=70^\circ C$	-33.5	
Pulsed Drain Current (Note 2)	I_{DM}	-300		
Avalanche Current	I_{AS}	-54		
Avalanche Energy	$L = 0.1mH$	E_{AS}	150	mJ
Power Dissipation (Note 3)	P_D	$T_C=25^\circ C$	119	W
		$T_C=100^\circ C$	47.5	
		$T_A=25^\circ C$	8.3	
		$T_A=70^\circ C$	5.3	
Thermal Resistance, Junction- to-Ambient (Note 4)	$R_{\theta JA}$	$t \leq 10s$	15	$^\circ C/W$
		Steady-State	60	
Thermal Resistance, Junction- to-Case	Steady-State	$R_{\theta JC}$	1.05	
Junction Temperature	T_J	150	$^\circ C$	
Junction Storage Temperature Range	T_{stg}	-55 to 150		

Notes

1. The maximum current rating is package limited.
2. Pulse width limited by maximum junction temperature.
3. The Power dissipation is based on $R_{\theta JA} t \leq 10s$ value.
4. The value of $R_{\theta JA}$ is measured with the device mounted on 1in² FR-4 board with 2oz. Copper, in a still air environment with $T_A = 25^\circ C$. The value in any given application depends on the user's specific board design.

P-Channel MOSFET

2KJ6058

■ Electrical Characteristics ($T_J = 25^\circ\text{C}$ Unless otherwise noted)

Parameter	Symbol	Test Conditions	Min	Typ	Max	Unit
Static Characteristics						
Drain-Source Breakdown Voltage	V_{DS}	$I_D = -250\mu\text{A}$, $V_{GS} = 0\text{V}$	-20			V
Zero Gate Voltage Drain Current	I_{DSS}	$V_{DS} = -16\text{V}$, $V_{GS} = 0\text{V}$			-1	μA
		$V_{DS} = -10\text{V}$, $V_{GS} = 0\text{V}$, $T_J = 125^\circ\text{C}$			-10	
Gate-Body Leakage Current	I_{GSS}	$V_{DS} = 0\text{V}$, $V_{GS} = \pm 12\text{V}$			± 100	nA
Gate Threshold Voltage	$V_{GS(th)}$	$V_{DS} = V_{GS}$, $I_D = -250\mu\text{A}$	-0.45	-0.55	-0.9	V
Drain-Source On-Resistance (Note 1)	$R_{DS(on)}$	$V_{GS} = -4.5\text{V}$, $I_D = -20\text{A}$		3	4	m Ω
		$V_{GS} = -2.5\text{V}$, $I_D = -10\text{A}$		3.8	5	
		$V_{GS} = -1.8\text{V}$, $I_D = -5\text{A}$		4.8	6	
Forward Transconductance	g_{FS}	$V_{DS} = -5\text{V}$, $I_D = -20\text{A}$		50		S
Dynamic Characteristics (Note 2)						
Input Capacitance	C_{iss}	$V_{GS} = 0\text{V}$, $V_{DS} = -10\text{V}$, $f = 1\text{MHz}$		8579		pF
Output Capacitance	C_{oss}			856		
Reverse Transfer Capacitance	C_{rss}			669		
Gate Resistance	R_g	$V_{GS} = 0\text{V}$, $V_{DS} = 0\text{V}$, $f = 1\text{MHz}$		2.6		Ω
Total Gate Charge	Q_g	$V_{DS} = -10\text{V}$, $I_D = -20\text{A}$, $V_{GS} = -4.5\text{V}$		101		nC
Gate Source Charge	Q_{gs}			9.3		
Gate Drain Charge	Q_{gd}			18		
Turn-On Delay Time	$t_{d(on)}$	$V_{DS} = -10\text{V}$, $I_D = -3.5\text{A}$, $V_{GS} = -4.5\text{V}$, $R_{GS} = 6\Omega$		37		ns
Turn-On Rise Time	t_r			60		
Turn-Off Delay Time	$t_{d(off)}$			250		
Turn-Off Fall Time	t_f			131		
Drain-Source Diode Characteristics						
Maximum Body-Diode Continuous Current	I_S				-19	A
Diode Forward Voltage	V_{SD}	$I_{SD} = -3.5\text{A}$, $V_{GS} = 0\text{V}$			-1.3	V
Reverse Recovery Time	t_{rr}	$I_F = -3.5\text{A}$, $di_F/dt = 100\text{A}/\mu\text{S}$		61		nS
Reverse Recovery Charge	Q_{rr}			47		nC

Notes 1. Pulse Test: Pulse Width $\leq 300\mu\text{s}$, Duty Cycle $\leq 2\%$.

2. Independent of operating temperature.

■ Marking

Marking	J6058 KC***
---------	----------------

P-Channel MOSFET

2KJ6058

■ Typical Characteristics

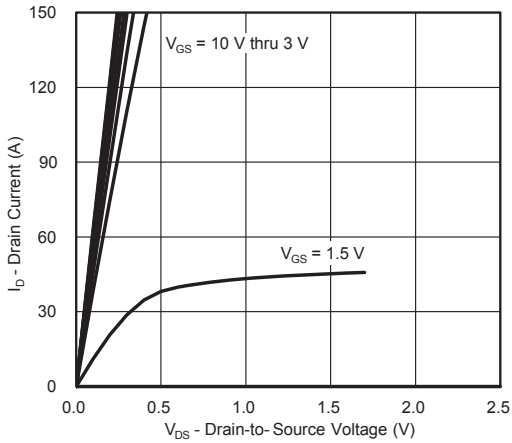

Output Characteristics

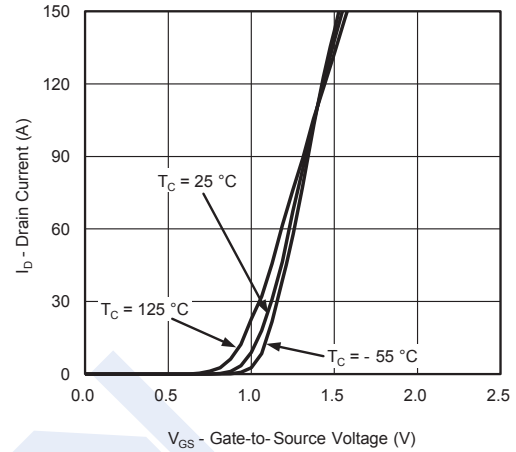

Transfer Characteristics

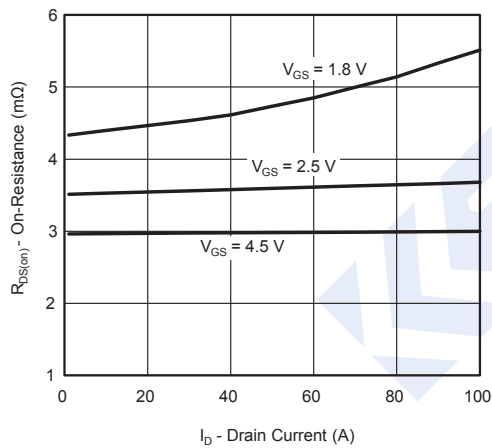

On-Resistance vs. Drain Current

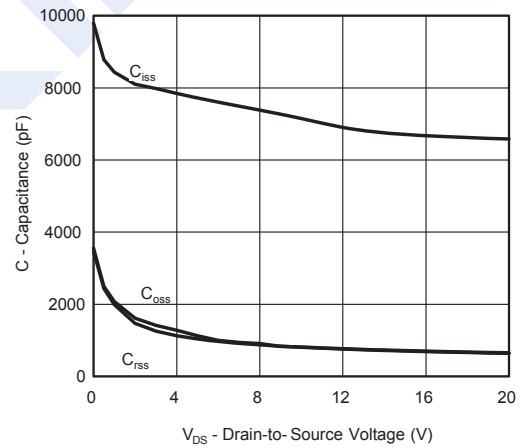

Capacitance

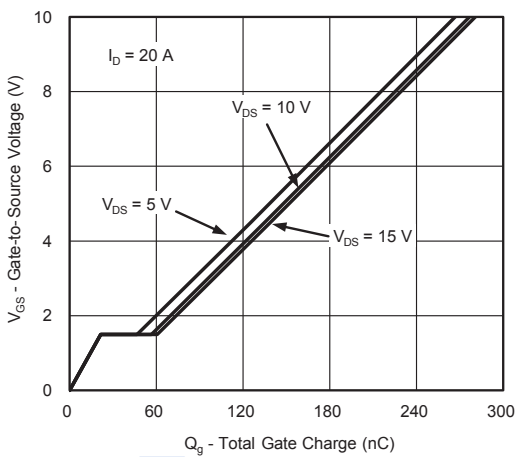

Gate Charge

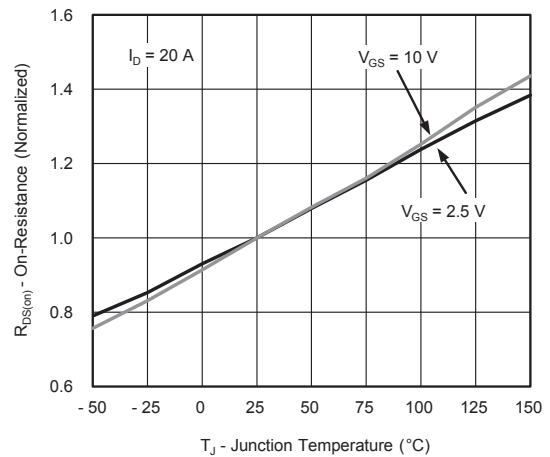

On-Resistance vs. Junction Temperature

P-Channel MOSFET

2KJ6058

