

## Schottky Diodes

### 1N5817FL ~ 1N5819FL

#### ■ Features

- Low power loss, high efficiency
- High current capability
- Low forward voltage drop
- High Surge Capability

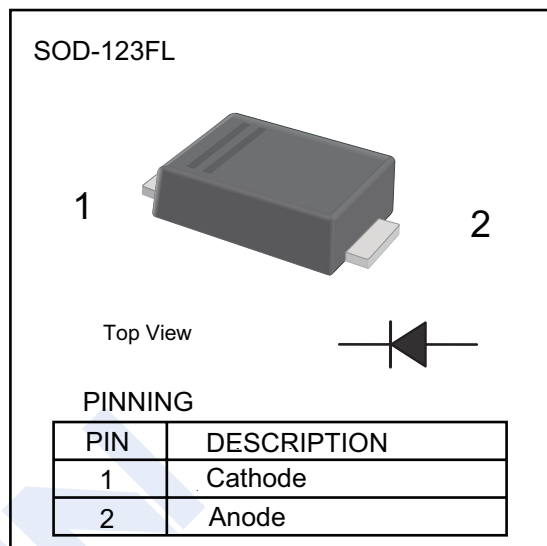

#### ■ Absolute Maximum Ratings $T_a = 25^\circ\text{C}$

Parameter	Symbol	1N5817FL	1N5818FL	1N5819FL	Unit
Peak Repetitive Reverse Voltage	VRRM	20	30	40	V
RMS Voltage	V <sub>RMS</sub>	14	21	28	
DC Blocking Voltage	V <sub>DC</sub>	20	30	40	
Forward Voltage @ $I_F=1\text{A}$	V <sub>F</sub>	0.45	0.55	0.6	
Forward Voltage @ $I_F=3.1\text{A}$		0.75	0.875	0.9	
Average Forward Rectified Current @ $T_L=90^\circ\text{C}$	I <sub>FAV</sub>	1			A
Non-Repetitive Peak Forward Surge Current @8.3ms	I <sub>FSM</sub>	25			
Reverse Voltage Leakage Current	I <sub>R</sub>	$T_a = 25^\circ\text{C}$	1		mA
		$T_a = 100^\circ\text{C}$	10		
Typical Junction Capacitance	C <sub>J</sub>	110			pF
Junction Temperature	T <sub>J</sub>	125			°C
Storage Temperature range	T <sub>stg</sub>	-55 to 125			

#### ■ Marking

NO.	1N5817FL	1N5818FL	1N5819FL
Marking	SJ	SK	SL

# Schottky Diodes

## 1N5817FL ~ 1N5819FL

■ Typical Characteristics

Fig.1 Forward Current Derating Curve

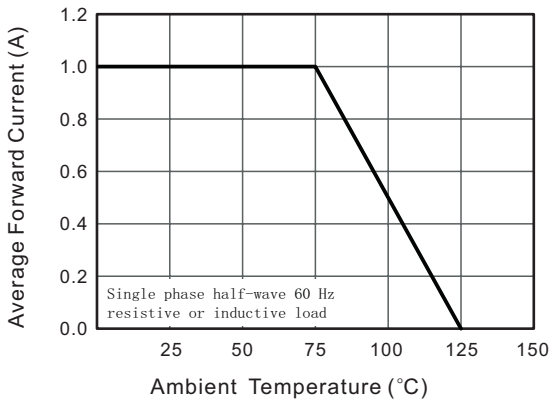

Fig.2 Typical Reverse Characteristics

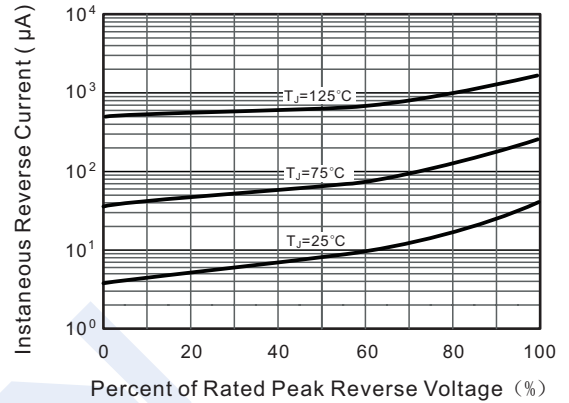

Fig.3 Typical Forward Characteristic

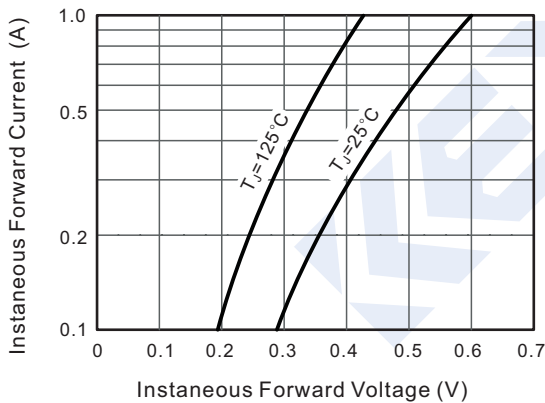

Fig.4 Typical Junction Capacitance

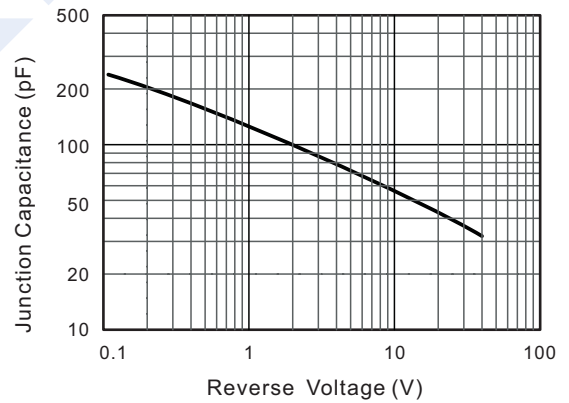

Fig.5 Maximum Non-Repetitive Peak Forward Surge Current

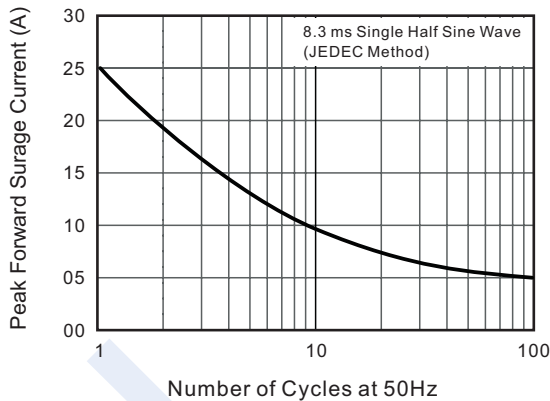
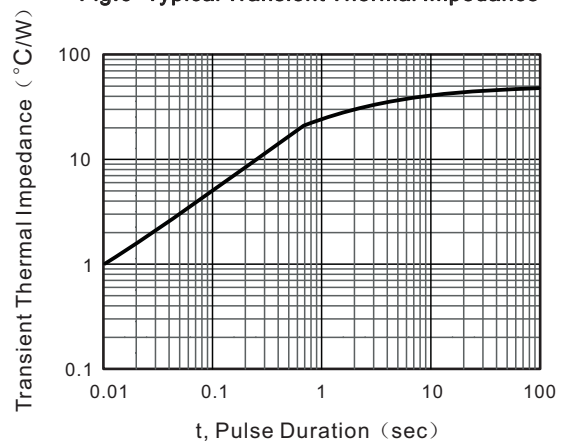

Fig.6- Typical Transient Thermal Impedance



## Schottky Diodes

### 1N5817FL ~ 1N5819FL

■ Package Outline Dimensions

Plastic surface mounted package; 2 leads

SOD-123FL

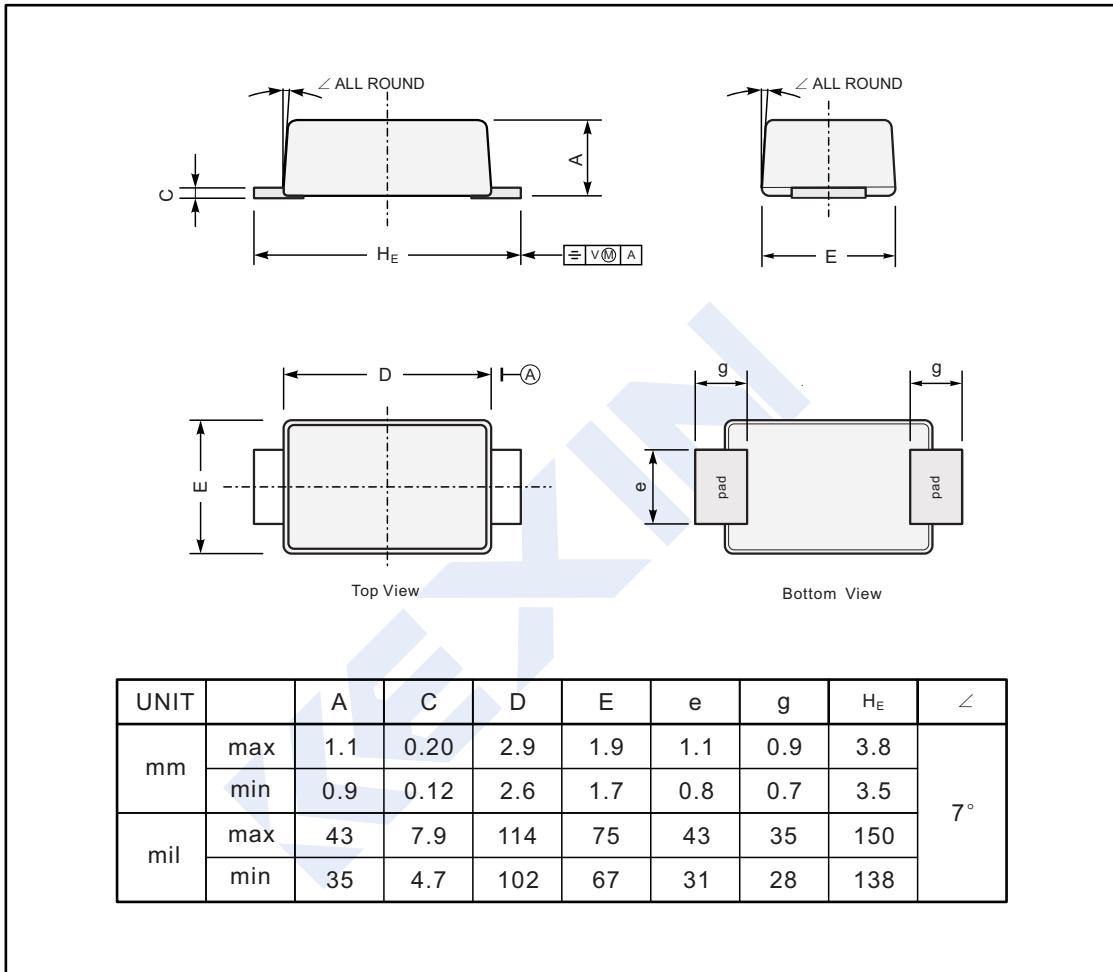

■ The Recommended Mounting Pad Size

